

LCHPX SERIES

High Power Line Scan LOW-COST

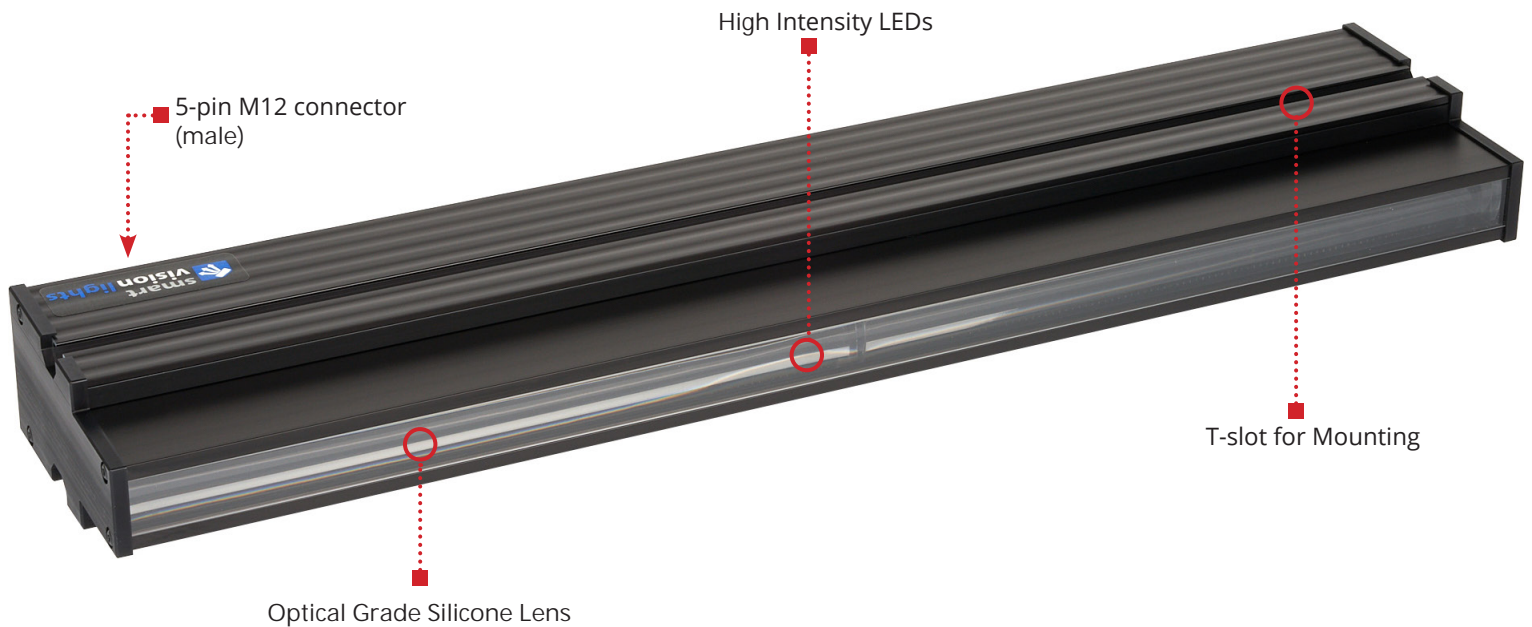

The LCHPX is a low-cost, high-powered line scan light that is capable of over 800,000 lux. This light can achieve high lux output without the need for internal fans. The LCHPX is fully enclosed and can be mounted using standard T-slot mounting hardware.

LCHPX HIGHLIGHTS

Warranty 3 YEAR	Tested IEC 62471	Compliant CE ROHS	Rated IP 50	Connector 5-PIN M12
-----------------------	------------------------	-------------------------	-------------------	---------------------------

- ✓ Capable of over 800,000 lux
- ✓ Passive cooling
- ✓ 5-Pin M12 connector
- ✓ Available in visible, IR, and UV wavelengths
- ✓ Durable optical grade silicone lenses

SPECIFICATIONS

Electrical Input	24 VDC +/- 5%
Input Current	Max. 1.6 A per 300 mm section
Power	Max. 38.4 W per 300 mm section
Connection	5-pin M12 connector
Operating Temperature	-10° to 40° C (14° - 104° F) RH max 80% non-condensing humidity
Storage Temperature	-20° to 70° C RH max 80% non-condensing humidity
IP Rating	IP50
Weight	~4.4 lbs ~2 kgs per 300 mm segment
Compliances	CE, FCC, RoHS, REACH, WEEE
Warranty	3 years*

*See SmartVisionLights.com/warranty for details

WIRING CONFIGURATION

CONTINUOUS OPERATION MODE

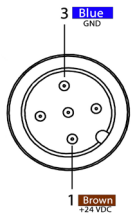

Pin layout for light (Male Connector)

Pins	Function	Signal	Wire Color
1	Power In	+24VDC	BROWN
2	Not Applicable	Not Applicable	WHITE
3	GND	Ground	BLUE
4	Not Applicable	Not Applicable	BLACK
5	Not Applicable	Not Applicable	GREY*

LIGHTING PATTERNS

*NOTE – Lens positions are set at Smart Vision Lights and are not user serviceable. See the following part number information for details. The following patterns are based on the LCHPX300.

Lens Position	Working Distance (mm)	Beam Width (mm)	Illuminance (Lux) Values
1	35	2.5	805,000
2	50	3	644,000
3	100	4.5	290,000
4	100	8	274,000

Illumination measurement taken on white light, 5700 K

LIGHTING PATTERNS (CONTINUED)

LENS POSITION 1

Intensity Map (at 35 mm Working Distance)

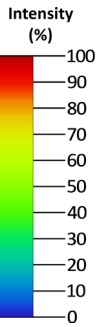
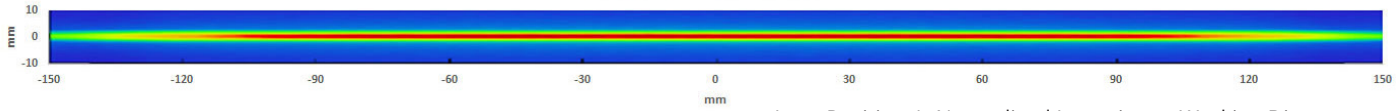

Lens Position 1: Beam Width vs. Working Distance

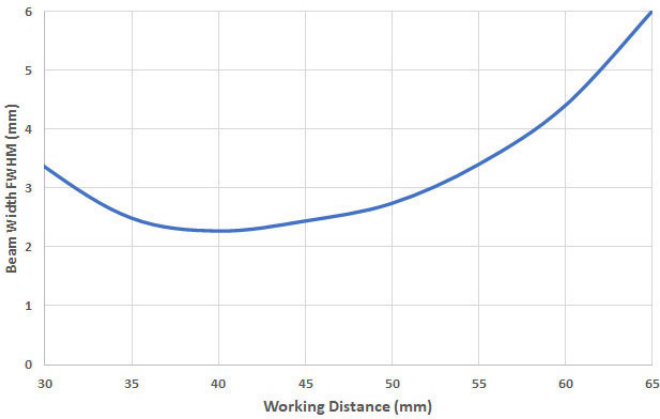

Lens Position 1: Normalized Intensity vs. Working Distance

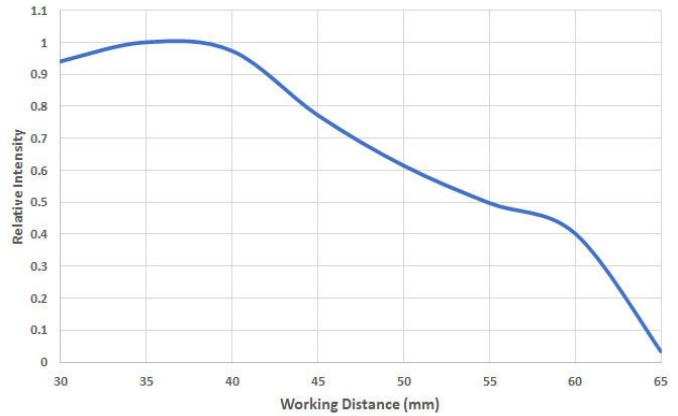

Lens Position 1: Horizontal Beam Profile at 35 mm Working Distance

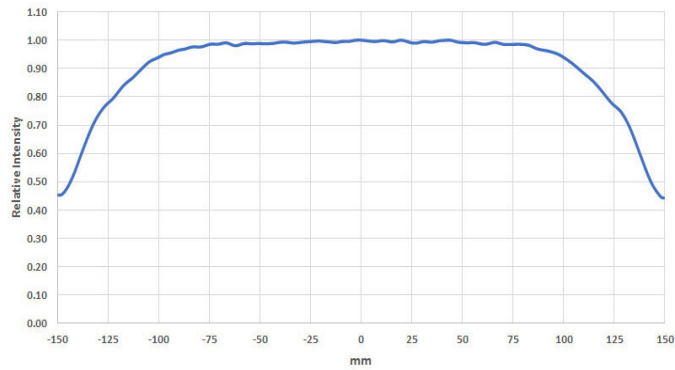

Lens Position 1: Beam Length (80% max) vs. Working Distance

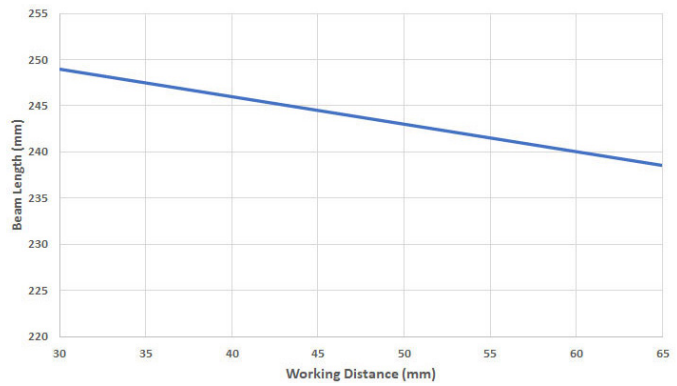

LIGHTING PATTERNS (CONTINUED)

LENS POSITION 2 (FACTORY DEFAULT)

Intensity Map (at 50 mm Working Distance)

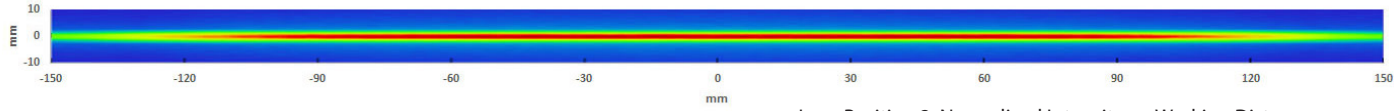

Lens Position 2: Beam Width vs. Working Distance

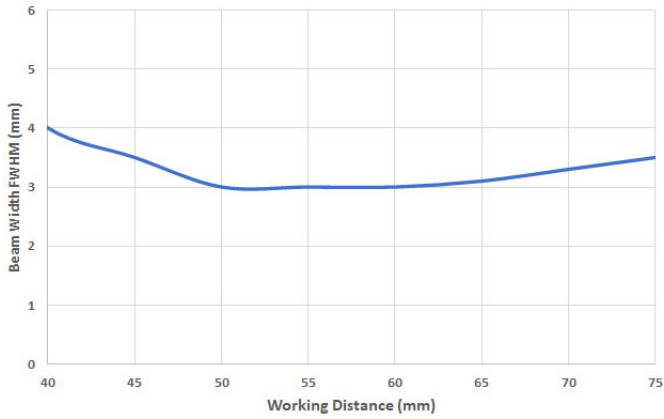

Lens Position 2: Normalized Intensity vs. Working Distance

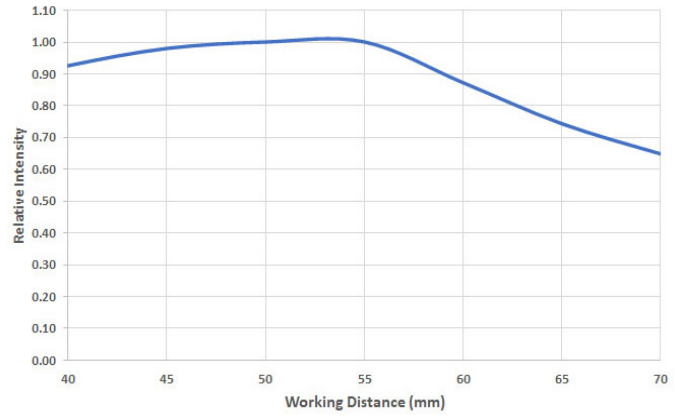

Lens Position 2: Horizontal Beam Profile at 50 mm Working Distance

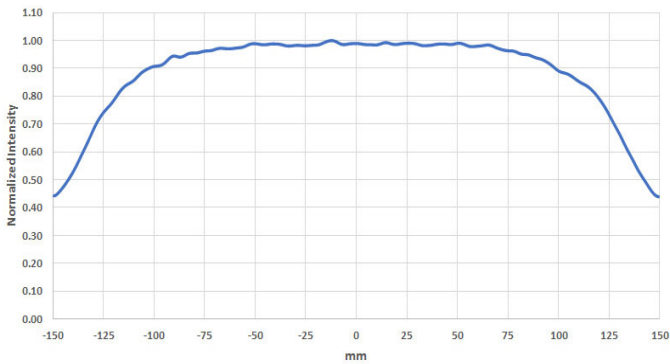

Lens Position 2: Beam Length (80% max) vs. Working Distance

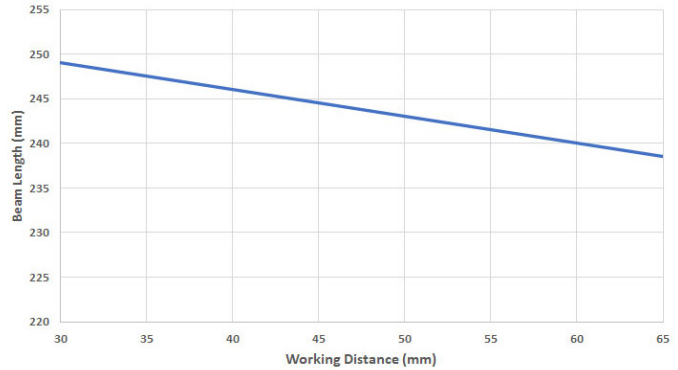

LIGHTING PATTERNS (CONTINUED)

LENS POSITION 3

Intensity Map (at 1000 mm Working Distance)

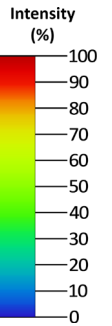
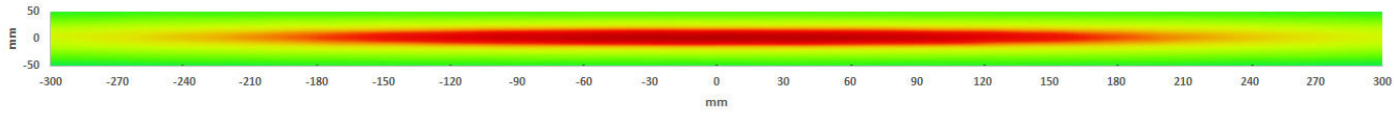

Lens Position 3: Beam Width vs. Working Distance

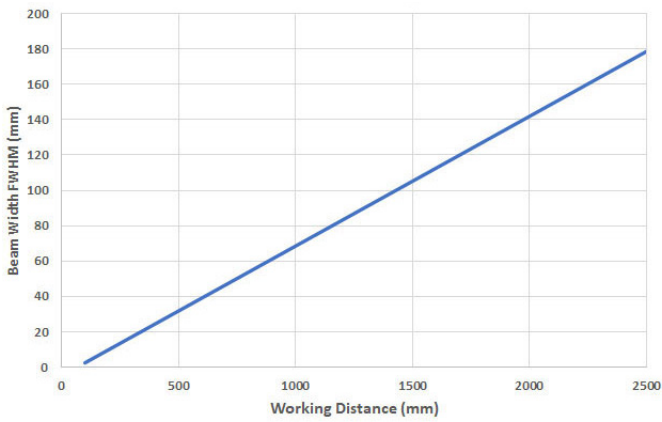

Lens Position 3: Normalized Intensity vs. Working Distance

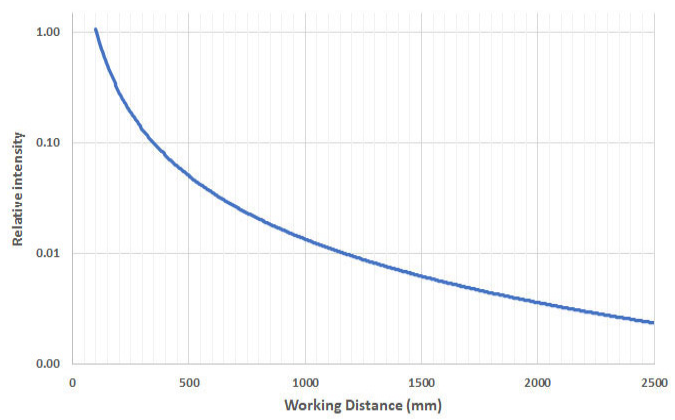

Lens Position 3: Horizontal Beam Profile at 100 mm Working Distance

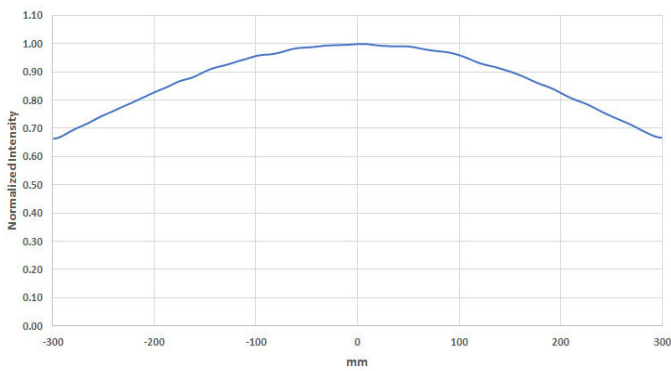

Lens Position 3: Beam Length (80% max) vs. Working Distance

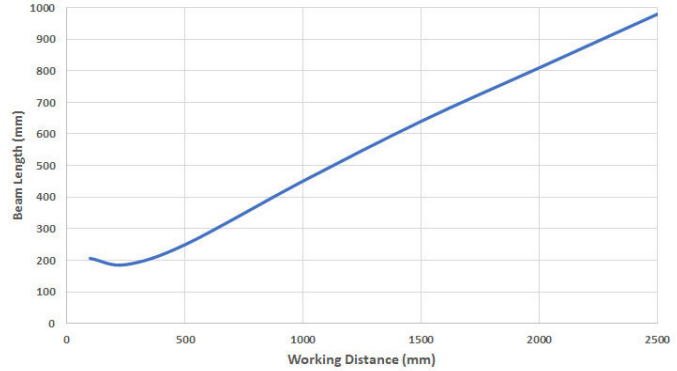

LIGHTING PATTERNS (CONTINUED)

LENS POSITION 4

Intensity Map (at 1000 mm Working Distance)

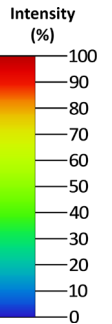
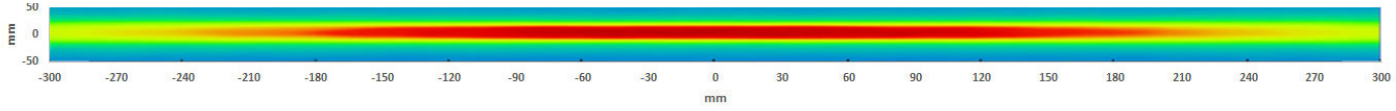

Lens Position 4: Beam Width vs. Working Distance

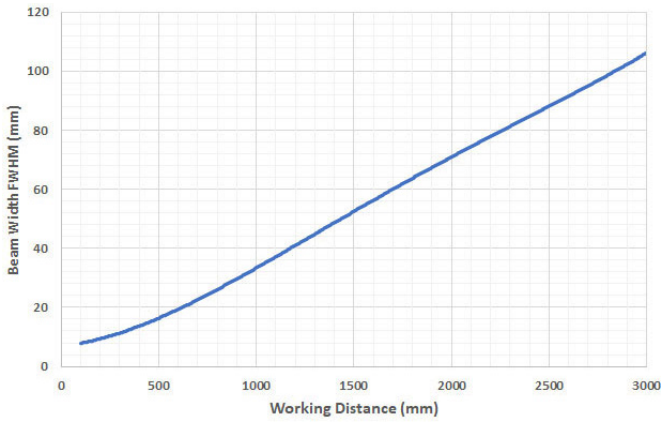

Lens Position 4: Normalized Intensity vs. Working Distance

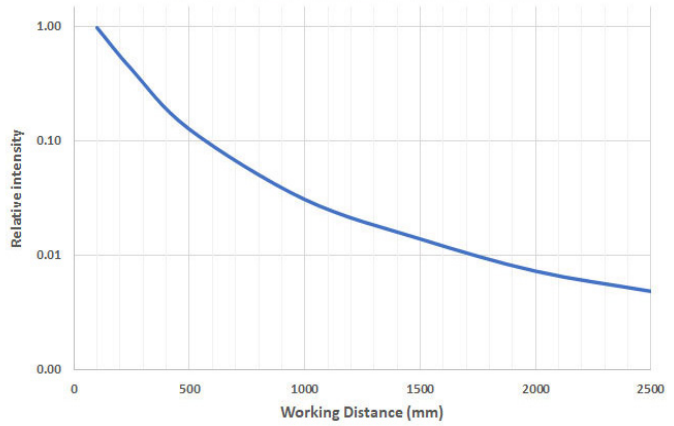

Lens Position 4: Horizontal Beam Profile at 100 mm Working Distance

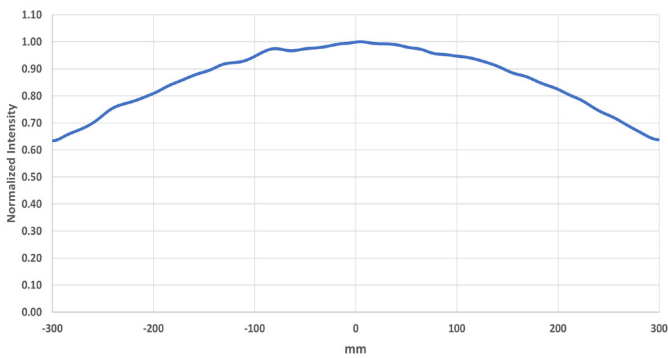

Lens Position 4: Beam Length (80% max) vs. Working Distance

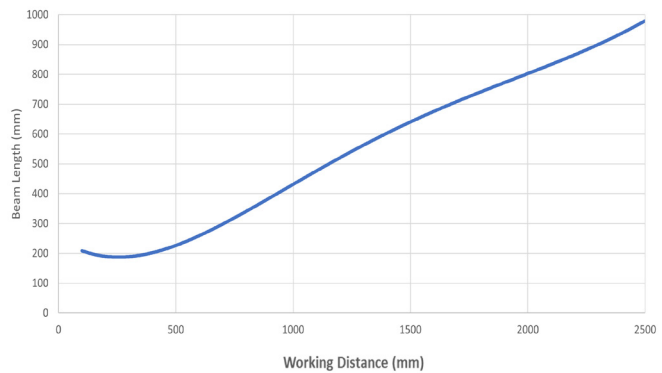

PART NUMBER GUIDE

LCHPX - -

SIZE:	COLOR:	LENS POSITION:
300 mm 600 mm 900 mm 1200 mm		1 2 (Factory Default) 3 4

Part Number Example:
LCHPX300-625-4 LCHPX, 300 mm, 625 (red) Wavelength, Lens Position 4

* Additional wavelengths and lens options available upon request.
 Every 300mm section comes with two screws and two T-nuts for mounting

ILLUMINATION

LCHPX Series of Line Scan Lights works best for:

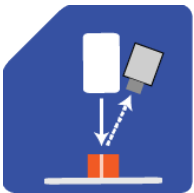

Line

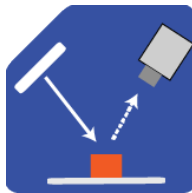

Bright Field

EYE SAFETY

According to IEC 62471:2006. Full documentation available upon request.

Notice

Exempt Group: No photobiological hazard to eyes or skin even for continuous, unrestricted use. Applicable for wavelength 625.

Caution

Risk Group 1: Possibly hazardous optical radiation emitted from this product. Do not stare at operating lamp. May be harmful to eyes. Safe for most applications except prolonged exposure. Applicable for wavelength WHI.

Caution

Risk Group 2: Possibly hazardous optical radiation emitted from this product. Do not stare at operating lamp. May be harmful to the eyes. Applicable for wavelength 470.

Warning

Risk Group 3: UV emitted from this product. Avoid eye and skin exposure to unshielded product. Applicable for wavelength 365.

MOUNTING

The LCHPX uses a T-slot mounting system. Two M5 screws and two T-nuts come with each 300mm section



ACCESSORIES

Mounting Kit	
	
Part Number	Description
SC0045	M5 X 8x10 mm screws
NU0016	T-nuts (80/20 part number 13115)

Light comes with two screws and two T-nuts per light per 300 mm section.

PRODUCT DRAWINGS (LCHPX300)

*CAD files available on our website
 Drawings are in mm

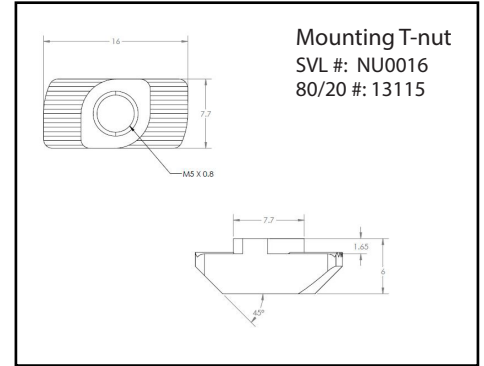
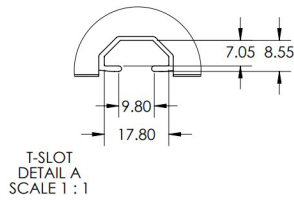
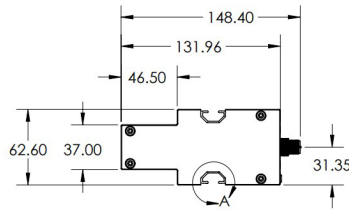
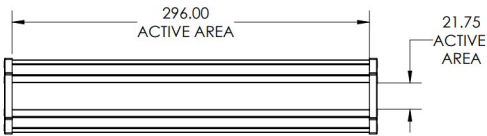
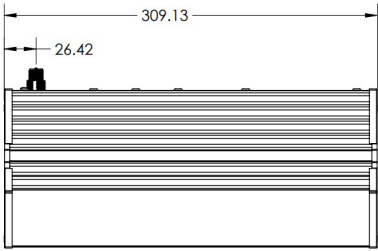

PRODUCT DRAWINGS (LCHPX600)

*CAD files available on our website
 Drawings are in mm

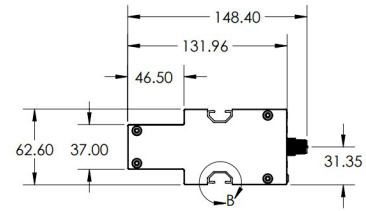
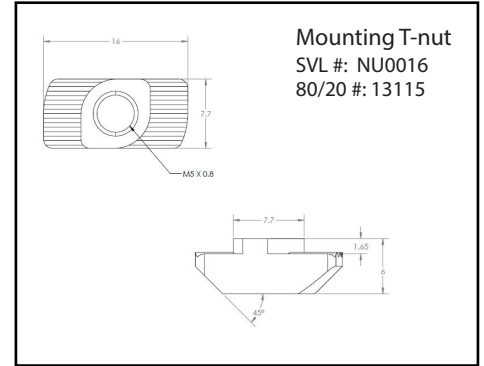
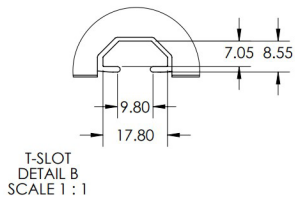
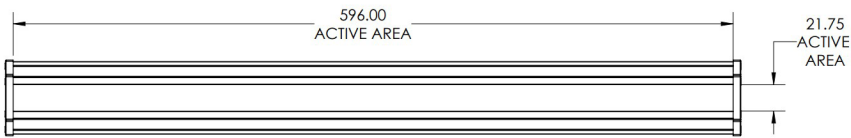
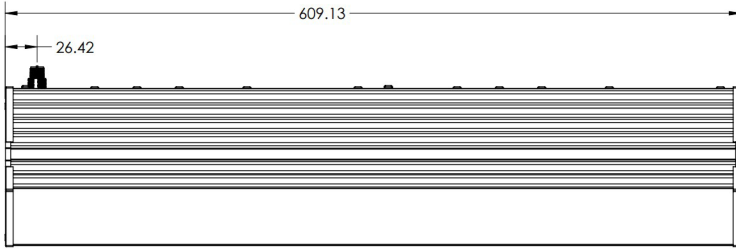

PRODUCT DRAWINGS (LCHPX900)

*CAD files available on our website
 Drawings are in mm

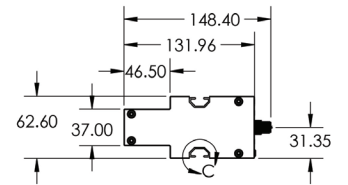
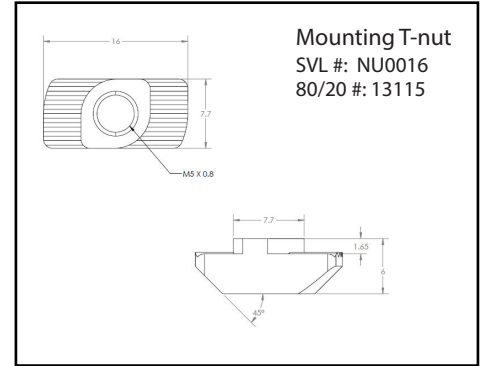
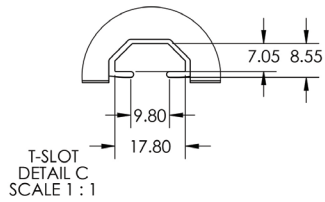
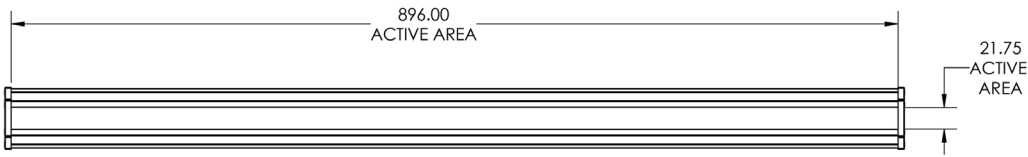
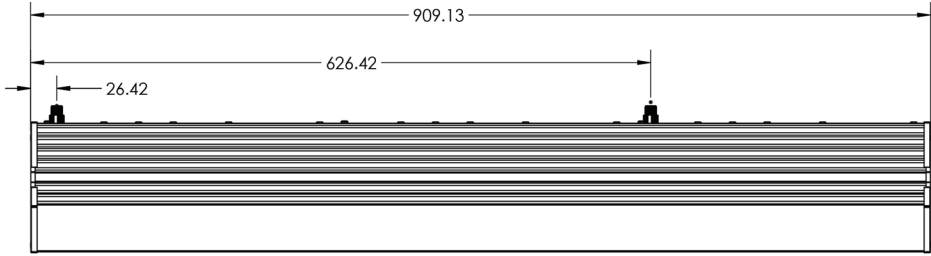

PRODUCT DRAWINGS (LCHPX1200)

*CAD files available on our website
 Drawings are in mm

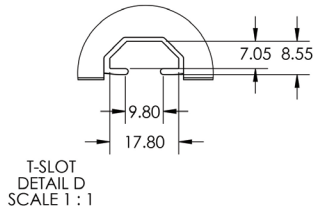
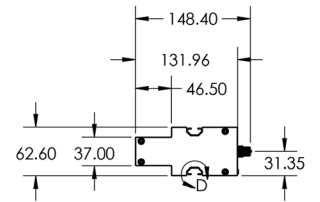
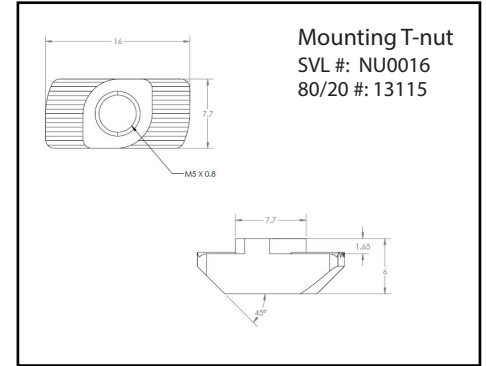
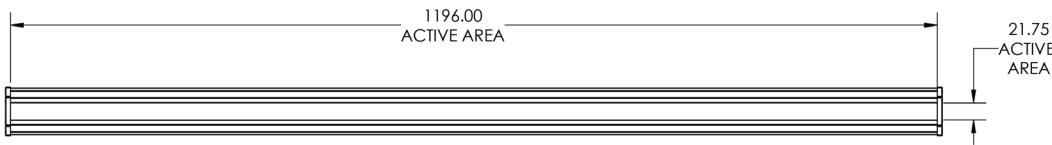
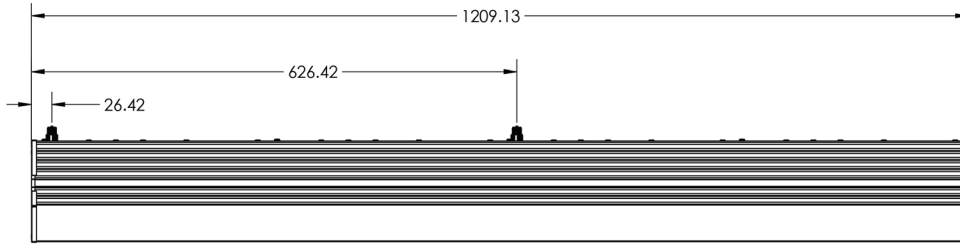

GLOSSARY

This glossary covers all Smart Vision Lights product families; some content in this section may not apply to this specific light.

TERMINOLOGY

Continuous Operation The light stays on continuously.

OverDrive™ Integrated driver that produces a high-current strobe to the LEDs to drive them beyond their nominal continuous operation output.

Multi-Drive™ Integrated driver that combines continuous operation and OverDrive™ strobe mode

NanoDrive™ Integrated driver that provides fast switching where the light can go from off to on in less than 500 ns.

Built-in Driver The driver contained within the light that controls the current to the LEDs and provides PNP, NPN, and analog dimming controls.

SmartVisionLink™ Integrated feature that enables lighting control through the Bluetooth module and app.

Camera to Light Connect the light directly to the camera, without the need for additional controllers or equipment.

Polarizers Filters that reduce reflections on specular surfaces.

Diffusers Widens the angle of emission by scattering light in all directions.

Pattern Area Lighting Modulated lighting pattern placed over a backlight's surface used to enhance defect detection on transparent and glossy surfaces

SafeStrobe Limiter to keep the light in safe working parameters.

Direct Connect Connect lights in a series without the use of cables.

Daisy-Chain Connect lights in a series with the use of cables.

TYPES OF ILLUMINATION

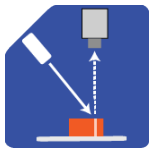

Projector

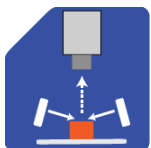

Dark Field

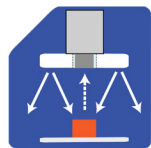

Radial



Bright Field

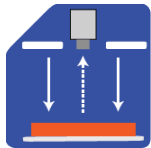

Direct

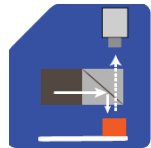

Axial

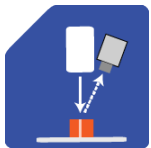

Line

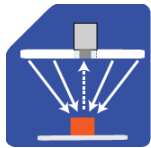

Diffuse Panel

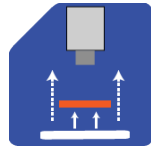

Backlight

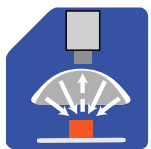

Dome
"Light Tent"

COMMON COLOR / WAVELENGTHS LEGEND

Wavelengths options range from 365 nm to 1650 nm.*
Additional wavelengths available for many light families.

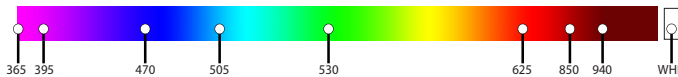

*See Part Number section for **this light's** available standard wavelengths.



Shortwave Infrared LEDs are available in 1050 nm, 1200 nm, 1300 nm, 1450 nm, 1550 nm, and 1650 nm.*

*Check Part Number section to see if **this light** is available in SWIR wavelengths.

For more information please contact:

BOCK OPTRONICS INC.
14 Steinway Blvd., Unit 7
Toronto, Ontario M9W 6M6

Tel: (416) 674-2804
sales@bockoptronics.ca
www.bockoptronics.ca



ISO 9001:2015 Certified QMS