

SSC-T800 series

Light Curtain Sensors











• New type with radial cross ray method

- Small objects and flat tape-like objects detected
- Convenient simplified wiring requiring no clock (synchronization) line
- Compact and flat (14.5 mm)
- Water resistance to IP 67

Light Curtain Sensors

Type

Detection method	Detecting distance	Light axis interval	No. of light axes	Detecting width	Set model No.	Detecting object
 Through-beam type	 100-500mm	5.55mm	10	50mm	SSC-T801	Opaque object of ϕ 6mm min.
	 0.4-1.2m				SSC-T802	Opaque object of ϕ 8mm min.
	 0.5-2m	12.5mm	5		SSC-T804	Opaque object of ϕ 15mm min.
	 100-500mm				SSC-T805	Opaque object of ϕ 12.5mm min.
	 150-800mm	16.6mm	10	150mm	SSC-T850	Opaque object of ϕ 17mm min.
					100mm	11mm
		20mm	6	SSC-T815		Opaque object of ϕ 20mm min.
		11mm	10	SSC-T830		Opaque object of ϕ 13mm min.
		20mm	6	SSC-T835		Opaque object of ϕ 22mm min.
		 0.5-2.5m	11mm	10	100mm	SSC-T830
 0.5-2.5m	20mm	6				

Radial Cross Ray Method

The transmitter emits light beams in a scanning manner and receiver accepts light beams of all axes at all times.

When Beam 1 is emitted, all of the receiving elements of the receiver receive the light. The sensor is activated when light beam of any of the light axes is blocked.

The figure on the right shows a model with six light axes. The number of light axes depends on the model.

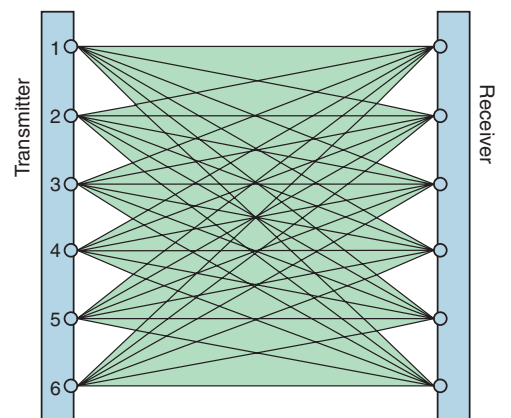

SSC-T800

Rating/Performance/Specification

Model	Set model No.	SSC-T801 (PN)	SSC-T802 (PN)	SSC-T804 (PN)	SSC-T805 (PN)	SSC-T850 (PN)	SSC-T810 (PN)	SSC-T815 (PN)	SSC-T830 (PN)	SSC-T835 (PN)
	Transmitter model No.	SSC-TL801	SSC-TL802	SSC-TL804	SSC-TL805	SSC-TL850	SSC-TL810	SSC-TL815	SSC-TL830	SSC-TL835
	Receiver model No.	SSC-TR801 (PN)	SSC-TR802 (PN)	SSC-TR804 (PN)	SSC-TR805 (PN)	SSC-TR850 (PN)	SSC-TR810 (PN)	SSC-TR815 (PN)	SSC-TR830 (PN)	SSC-TR835 (PN)
Detection method	透過形									
Detecting distance	100-500mm	0.4-1.2m	0.5-2m	100-500mm	150-800mm			0.5-2.5m		
Detection object	Opaque object of ϕ 6mm min.	Opaque object of ϕ 8 mm min.	Opaque object of ϕ 15 mm min.	Opaque object of ϕ 12.5 mm min.	Opaque object of ϕ 17 mm min.	Opaque object of ϕ 11 mm min.	Opaque object of ϕ 20 mm min.	Opaque object of ϕ 13 mm min.	Opaque object of ϕ 22 mm min.	
No. of light axes	10		5		10		6	10	6	
Detecting width	50mm				150mm	100mm				
Light axis interval	5.55mm		12.5mm		16.6mm	11mm	20mm	11mm	20mm	
Power supply	12-24V DC \pm 10% / Ripple 10% max.									
Current consumption	Transmitter	50mA max.		70mA max.		80mA max.		80mA max	80mA max	80mA max
	Receiver	100mA max. *		65mA max. *		110mA max. *		70mA max. *	110mA max. *	70mA max. *
Output mode	NPN open collector Rating: sink current 100 mA (30 VDC max.) Models with model Nos. ending with X-PNE have PNP open collector output; source current: 100 mA max.									
Operation mode	Activated when light beams of all axes are received (deactivated when light beam of any axis is blocked)									
Response time	Light blocking :5ms max. Light reception 8ms max.		Light blocking :3ms max. Light reception 4ms max.		Light blocking :5ms max. Light reception 8ms max.					
Light source (wavelength)	Infrared LED (860nm)									
Indicator	Transmitter: Power indicator (green LED) Receiver: Power indicator (green LED) / Operation indicator (OrangeLED)									
Short circuit protection	Provided									
Material	Case body: Aluminum / Caps at ends: glass fiber filled PBT									
Connection	Permanently attached cord (Outer dimension: dia.4) Cord length: 3 m Cord: with two 0.3 mm ² cores, gray (transmitter) or with three 0.3 mm ² cores black (receiver) covering									
Mass	About 130 g (transmitter/receiver)				About 190 g (transmitter/receiver)	About 130 g (transmitter/receiver)				
Accessory	Operation manual (Note) Mounting brackets are not provided									
Notes	*The receiver current consumption shown is for 12 VDC. When the voltage is 24 VDC, the consumption is reduced to about 60%. *1 "-D" types, or models deactivated when light beams of all axes are received, are also available.									

Environmental Specification

Environment	Ambient light	5,000lx max.
	Ambient temperature	-10 - +55°C (non-freezing)
	Ambient humidity	35-85%RH (non-condensing)
	Protective structure	IP67
	Vibration	10-55 Hz / 1.5 mm amplitude / 2 hours each in 3 directions
	Shock	500 m/s ² / Twice each in 3 directions
	Dielectric withstanding	500 VAC for 1 minute
	Insulation resistance	500 VDC, 20 M Ω or higher.

• Applicable power supply unit

PS Series
High capacity of 200 mA at 12 VDC

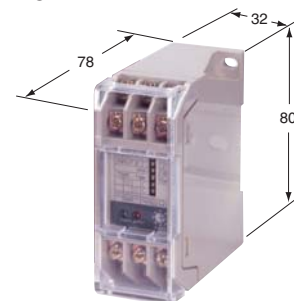

(General-purpose type) PS3N
PS3N-SR
(Multifunctional type) PS3F
PS3F-SR

SSC-T800

Input/Output Circuit and Connection

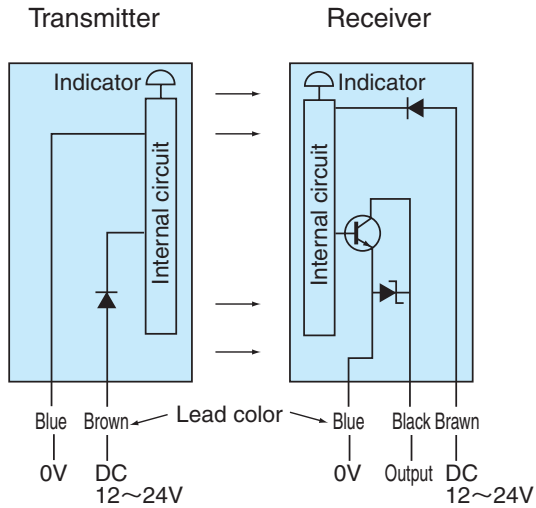

The output transistor turns off when load short circuits or overload occurs. Check the load and turn the power back on

Setting

Install the transmitter and receiver face-to-face.

Swivel the transmitter and receiver vertically and horizontally to install them at the center of the area in which the operation indicator (orange LED) is illuminated for the individual direction.

The tightening torque for installing the sensor (with M4 screws) should be up to 0.6 N·m.

- Displacement in the A direction may be up to $\pm 30\text{mm}$. Displacement in the B direction should be within $\pm 10\text{mm}$.
- If the transmitter and receiver are too closely installed to each other or light axes are misaligned, the output may be unstable. When the light axes are aligned, the operation returns to normal.

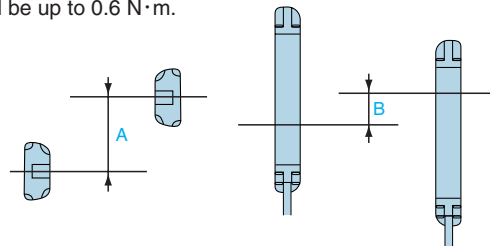

- Any reflecting object (wall, floor, machine, etc.) within the effective range between the transmitter and receiver may allow the light of the sensor to go around the detection object, which is supposed to block the light, and reach the receiver. Choose the installation location carefully. Any glossy object such as a coated surface in the surrounding area must be at least 100mm away for the distance setting of within 1m and 150mm away for the distance setting of over 1m.
- Use caution with interference when installing sensor adjacently.

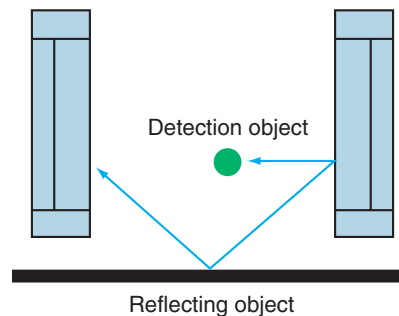

For Correct Use



- Be sure to follow the instructions in the operation manual provided for correct use of the product.
- This sensor cannot be used as a press safety device or other safety device for protection of human body that requires conformity to domestic or overseas standards or certification concerning protection of human body. Use for such purposes may lead to death or serious injury in the unlikely event of failure.
- This sensor is intended for detection of ingress of human body or object passing through an arbitrary point not involving protection of human body or safety.
- When using this sensor for safety purposes, ensure safe operation of the system as a whole including detection and control.

Characteristics (Typical Example)

- Parallel displacement characteristics

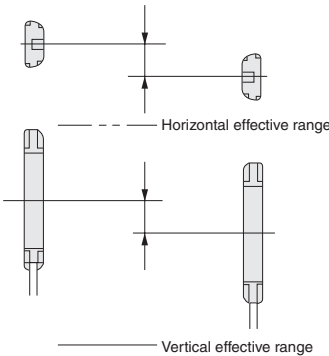
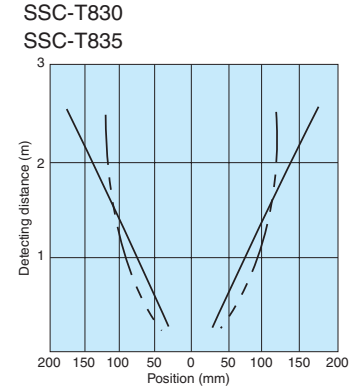
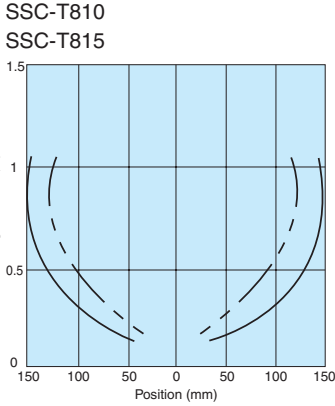
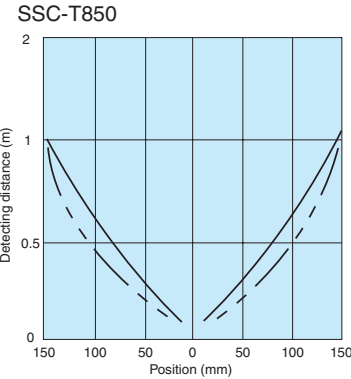
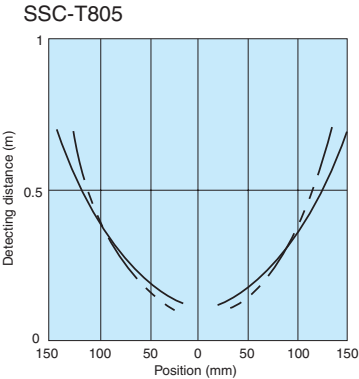
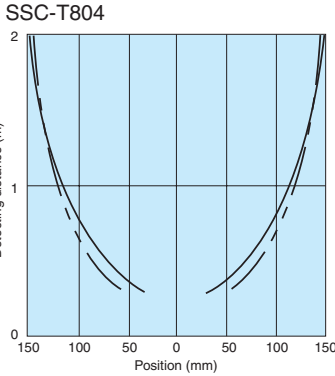
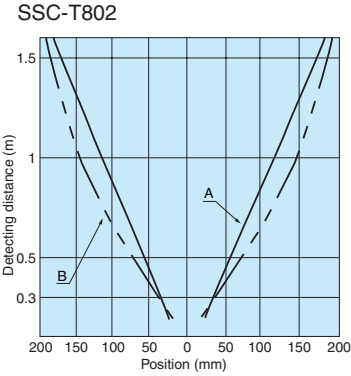
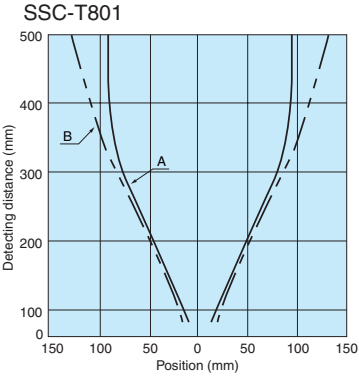

Light Curtain Sensors

SSC-T800

Characteristics (Typical Example)

- Operating angle characteristics

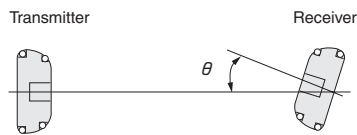
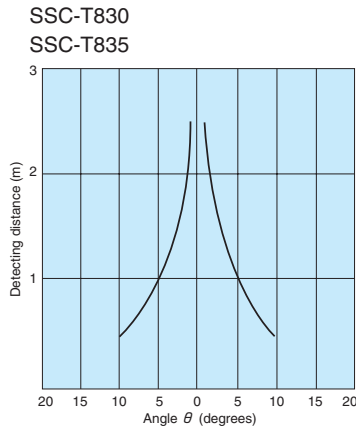
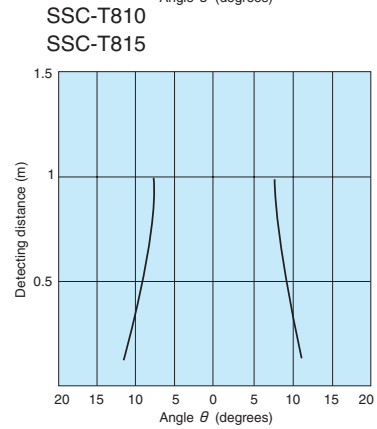
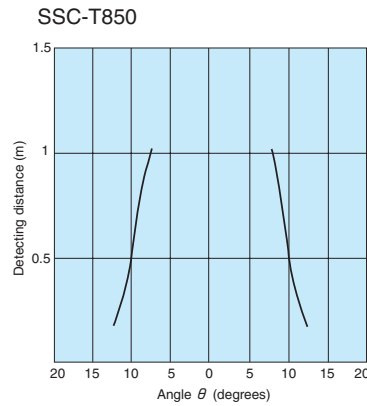
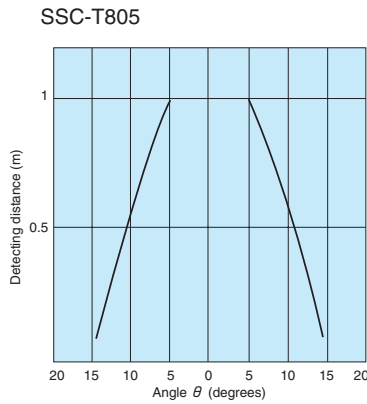
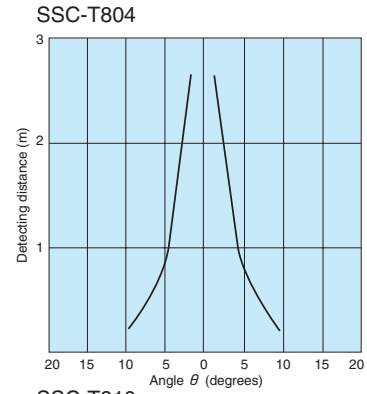
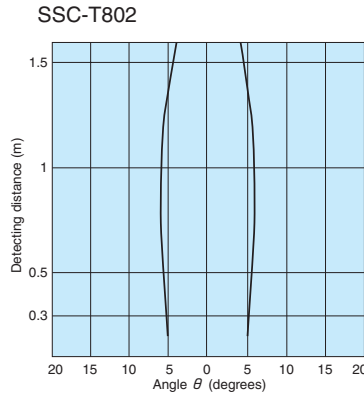
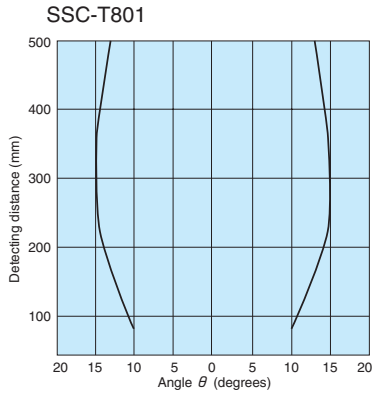

Characteristics (Typical Example)

- Smallest detectable object diameter characteristics

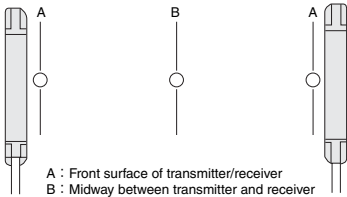
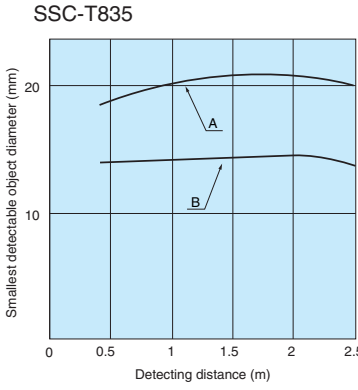
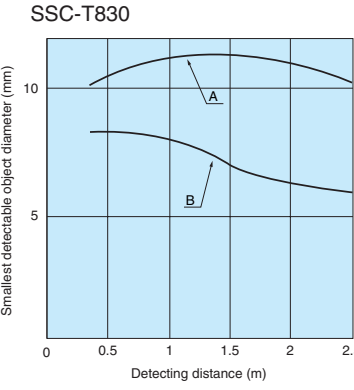
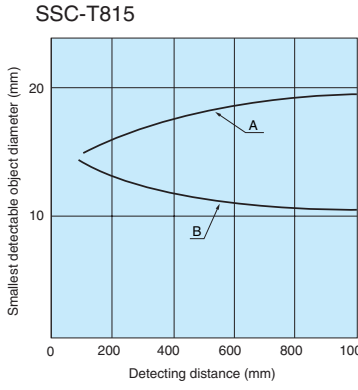
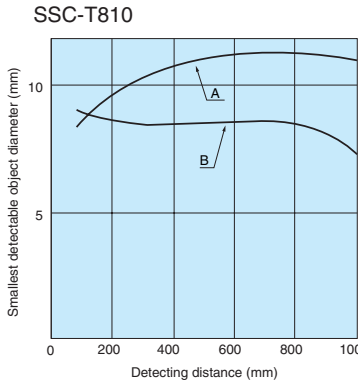
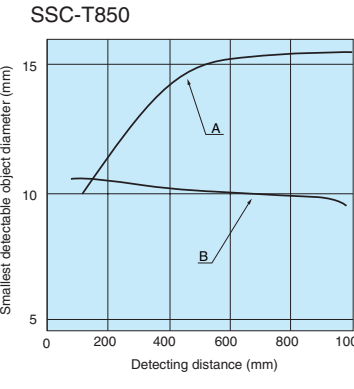
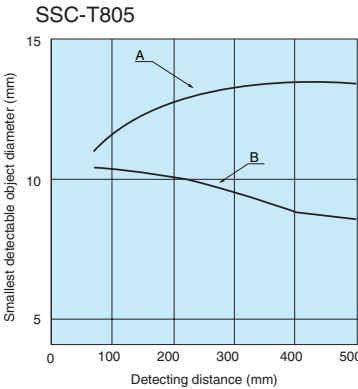
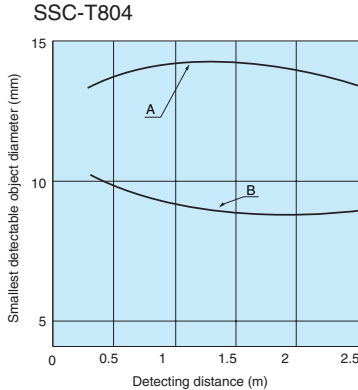
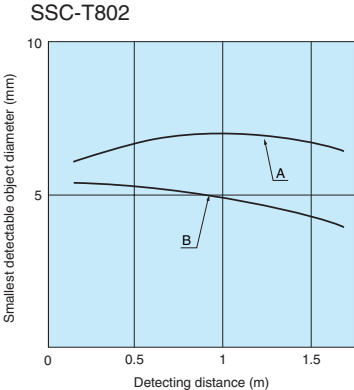
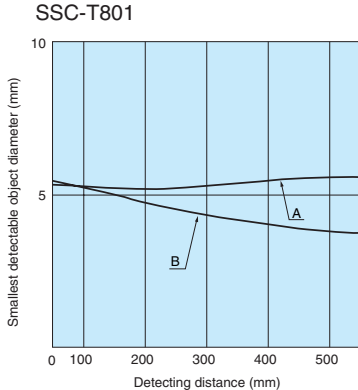

SSC-T800

Dimensions (in mm)

SSC-T801 SSC-T804
SSC-T802 SSC-T805

CAD

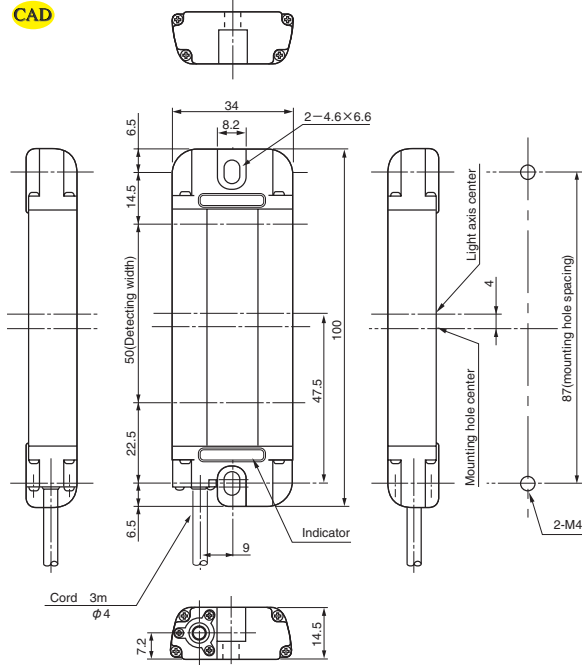

SSC-T850

CAD

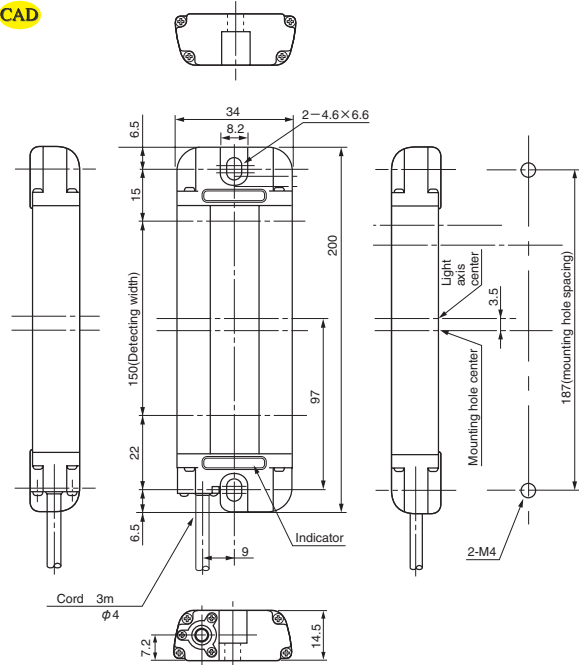

SSC-T810
SSC-T830

CAD

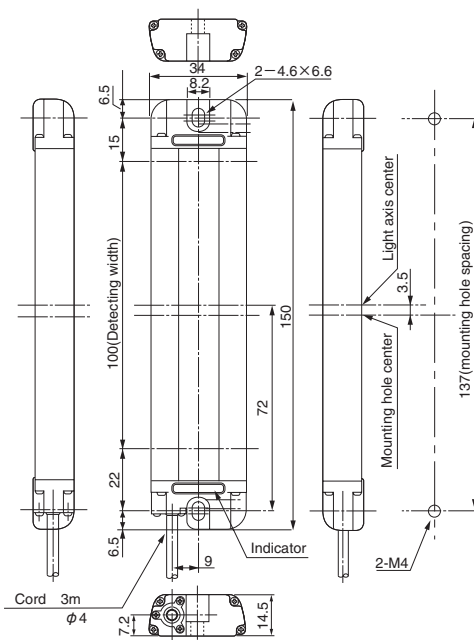

SSC-T815
SSC-T835

CAD

