

# Middle-G Series Embedded Amplifier Photo Sensors

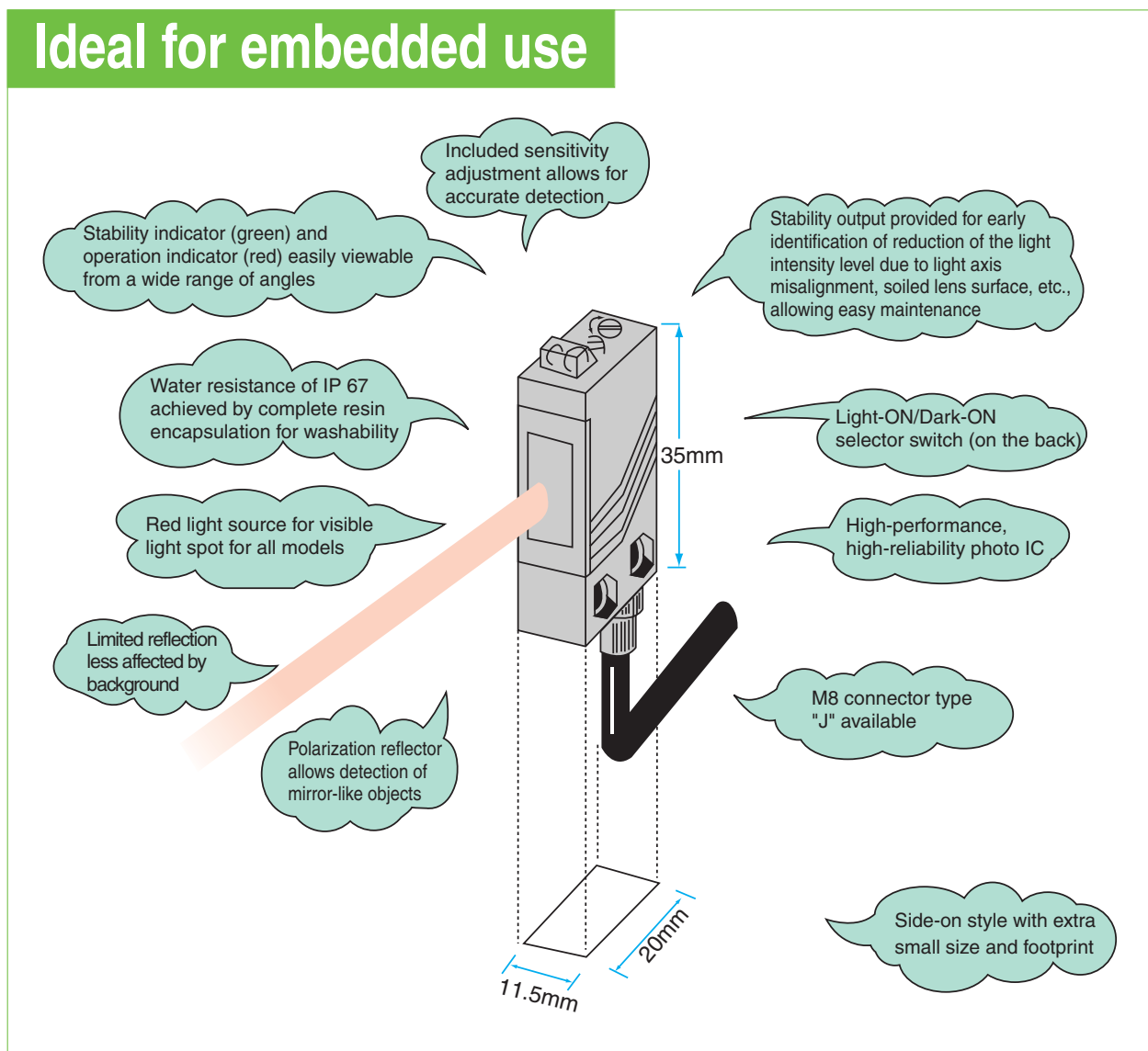







- IP 67 water resistance
- Detects mirror-like materials (mirrors, glossy objects) (polarization reflector type)
  - Switch selectable operation mode
  - Sensitivity adjustment for fine detection
  - Globally compatible PNP types also conveniently provided with stability output
  - Optional rigid protective cover (mounting bracket) available

## Ideal for embedded use

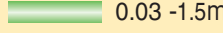

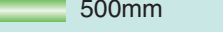
## Type

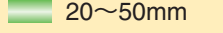
Detection method	Detecting distance	Model		Operation mode	Output mode
		Side-on type	Head-on type		
 Through-beam type	 7m	GT5RSN	----	Light-ON/ Dark-ON selectable  (with switch)	NPN open collector  { PNP output type also available }
		GT5RSN-J	----		
		----	GT5RN		
		----	GT5RN-J		
 Polarization reflector type	 0.03 -1.5m	GMR2RSN	----		
		GMR2RSN-J	----		
		----	GMR2RN		
		----	GMR2RN-J		
 Diffuse-reflective type	 500mm	GSR05RSN	----		
		GSR05RSN-J	----		
		----	GSR05RN		
		----	GSR05RN-J		
 Limited reflection type	 20~50mm	GSZ5RS	----		
		GSZ5RS-J	----		
		----	GSZ5R		
		----	GSZ5R-J		

### • PNP output type

PNP output types are available for all models.

PNP output type models are identified by "PN" at the end of model number.

The rating/performance other than the output is the same as NPN type.

### Protective cover

G-MSB1  
(For side-on style)

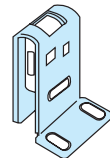

G-MTB1  
(For side-on style)

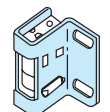

G-MTB2  
(For head-on style)

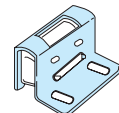

G-K7B  
(For reflector)

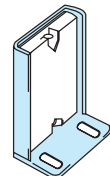

## Optional Parts

Type	Model	Applicable model	Description
Reflector	K-7	All polarization reflector type models	Detecting distance With K-7: 0.03-2.5 m With S-25: 70-400 mm
	S-25 *		
Protective cover	G-MSB1	Side-on type models	Rigid SUS covers for protecting sensors and reflectors from impact, etc.
	G-MTB1	Head-on type models	
	G-MTB2	K-7 and K-71 reflectors	
	G-K7B		
Cord with M8 connector	FBC-4R2S	M8 connector type sensor models with "-J"	Straight (2 m)
	FBC-4R2L		Angled (2 m)

\* One sheet contains 25.

For dimensions, see "Dimensions (protective cover)."

# Middle-G

## Rating/Performance/Specification

Model	Side-on	GT5RSN	GMR2RSN	GSR05RSN	GSZ5RS
	Head-on	GT5RN	GMR2RN	GSR05RN	GSZ5R
Detection method		Through-beam type	Polarization reflector type	Diffuse-reflective type	Limited reflection type
Detecting distance		7m	0.03 - 1.5m*	500mm	20 - 50mm
Detection object		φ 20mm (Min.) Opaque	Glossy objects including mirror-like materials and stainless-steel plates or opaque objects	Standard detection object: 100 x 100mm white drawing paper	_____
Power supply		12 - 24V DC ±10% / Ripple 10% max. (*15 V power supply)			
Current consumption		Transmitter: 20 mA max. Receiver: 20 mA max.	30mA max.		
Output mode	Control output	NPN open collector output Rating: sink current 100 mA (30 V DC) max. (PNP output type also available)			
	Stability output	NPN open collector output Rating: sink current 50 mA (30 V DC) max. (PNP output type also available)			
Operation mode		Light-ON/Dark-ON selectable (with switch)			
Response time		0.5ms max.			
Hysteresis		_____		10% max.	
Operating angle		10° (at receiver)	30° (reflector)	_____	
Light source (light wavelength)		Red LED (700nm)			
Indicator		Transmitter: power indicator (red LED) Receiver: operation indicator (red LED) Stability indicator (green LED)	Operation indicator (red LED) Stability indicator (green LED)		
Volume		SENS: sensitivity adjustment (on receiver for through-beam type)			
Switch		Light-ON/Dark-ON selector switch provided			
Short circuit protection		Provided (for control output only)			Provided
Material	Case	Polyarylate			
	Lens	Acrylic			
Connection		Permanently attached cord (outer dimension: dia. 4.2) Transmitter of through-beam type: 0.3 sq. 2 m length(gray) Receiver of through-beam type: 0.2 sq. 4 core 2 m (black)			
Mass		About 80 g (transmitter/receiver)	About 80g		
Notes		K-71 reflector provided		Screwdriver for sensitivity adjustment provided	
		*1 Contact Takex for 5 VDC power supply models available for head-on types. • All models are provided with a mounting bracket. Polarization reflector types are provided with a bracket for reflector and adhesive sheet for mounting the reflector.			

## Environmental Specification

Environment	Ambient light	5,000 lx max.
	Ambient temperature	-25 - +55°C (non-freezing)
	Ambient humidity	35~85%RH (non-condensing)
	Protective structure	IP67
	Vibration	10-55 Hz / 1.5 mm amplitude / 2 hours each in 3 direction
	Shock	500 m/s <sup>2</sup> / 3 times each in 3 directions
	Dielectric withstanding	1,000 VAC for 1 minute
	Insulation resistance	500 VDC, 20 MΩ or higher

### \*Detecting distances for different reflectors

- The detecting distance depends on the reflector used.

Reflector model	K-71	K-7	S-25
Detecting distance	0.03 - 1.5m	0.03 - 2.5m	70 - 400mm

## Input/Output Circuit and Connection

### NPN output

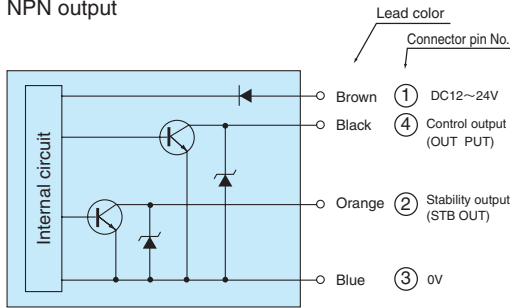

### PNP output

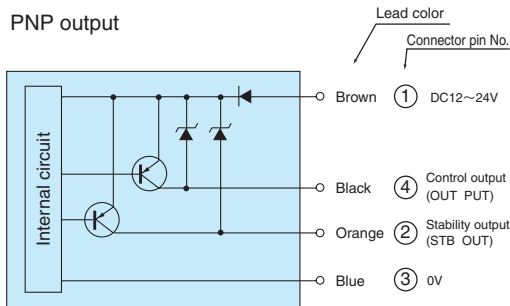

- The transmitter is provided with power supply lines (brown: 12-24 VDC; blue: 0 V) only.
- The output transistor turns off when load short circuit or overload occurs.
- Check the load and turn the power back on.

### M8 connector type (-J) pin assignment and connection (Receiver/reflective type sensor)

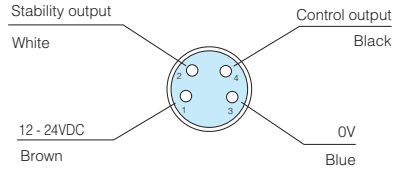

The colors show lead colors for use in combination with the optional cord with M8 connector.

### (Transmitter)

Lines other than Lines 1 (brown) and 3 (blue) are unused.



## Characteristics (Typical Example)

### Directional characteristics

GT5RSN · GT5RN

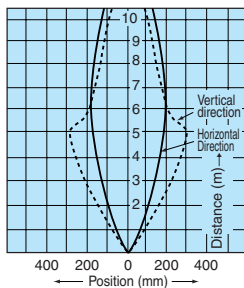

GMR2RSN (K-7)  
GMR2RN (K-71)

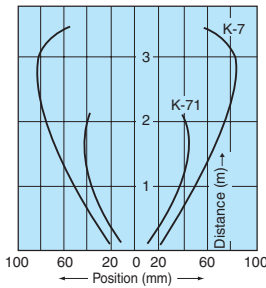

GMR2RSN (S-25)  
GMR2RN (S-25)

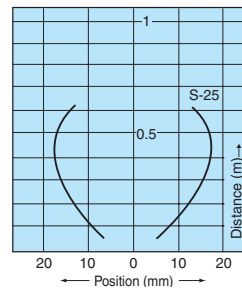

### Operating angle characteristics

GMR2RSN · GMR2RN

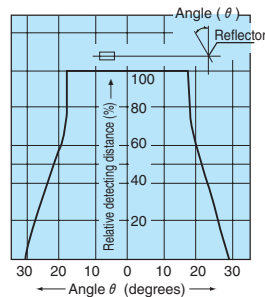

### Activation area characteristics

GSR05RSN · GSR05RN

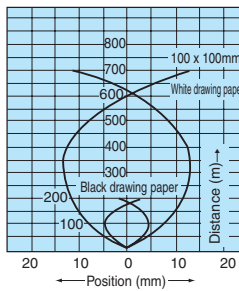

### Distance-area characteristics

GSR05RSN · GSR05RN

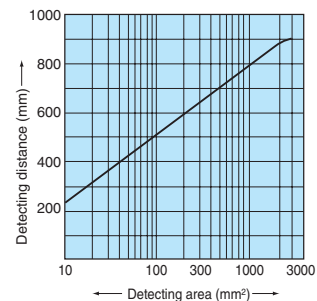

# Middle-G

Dimensions (in mm; tightening torque for mounting screws: 0.6 N-m max.)

Embedded Amplifier Photo Sensors

GT5RN  
GMR2RN  
GSR05RN  
GSZ5R

CAD

(Head-on) typical example

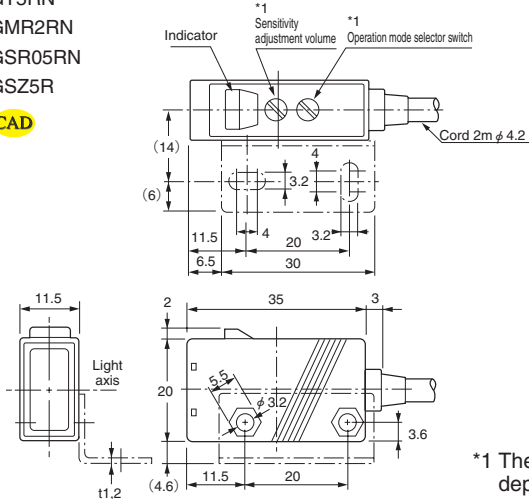

\*1 The operating side depends on the model.

(Side-on) Typical example

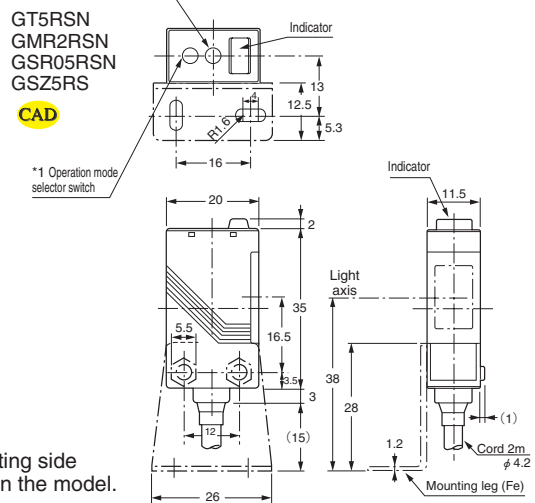

CAD

(K-71 reflector)

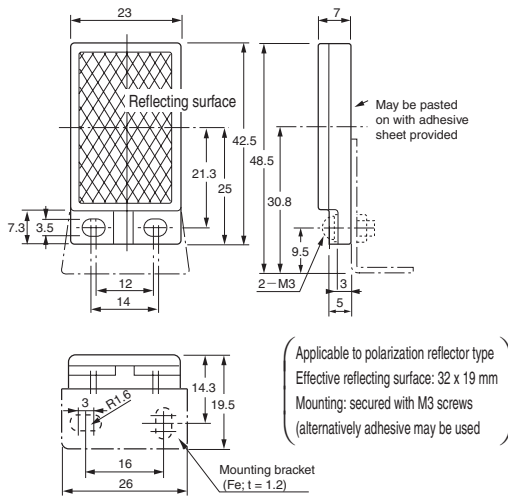

(Mounting bracket in different orientation)

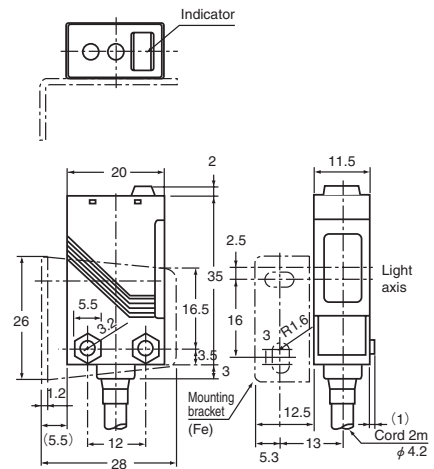

CAD

"-J" (M8 connector type) head-on model

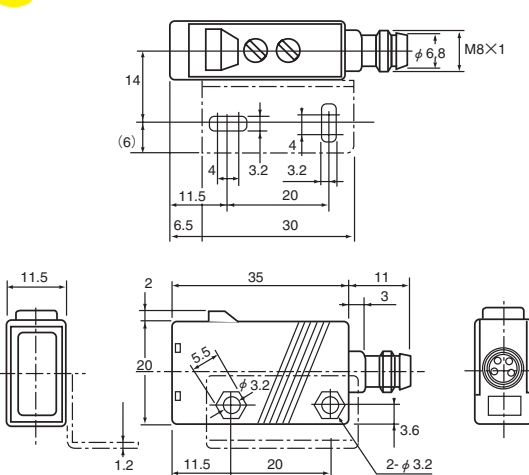

CAD

"-J" (M8 connector type) side-on model

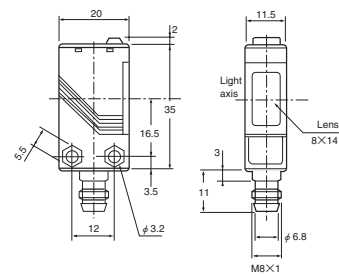

FBC-4R2S (Straight)

CAD

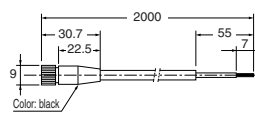

FBC-4R2L (Angled)

CAD

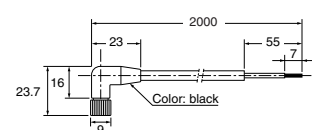

## Dimensions (protective cover) (in mm)

<p><b>G-MSB1 (side-on)</b></p> <p><b>CAD</b></p>	<p><b>G-MTB2 (head-on)</b></p> <p><b>CAD</b></p>
<p><b>G-MTB1 (side-on)</b></p> <p><b>CAD</b></p>	<p><b>G-K7B (reflector)</b></p> <p><b>CAD</b></p> <p>A for K-7 B for K-10 C for K-71 C' for reverse mouting of K-71</p>

## Operation Mode Switching

- Operation mode selector switch is provided for all models.

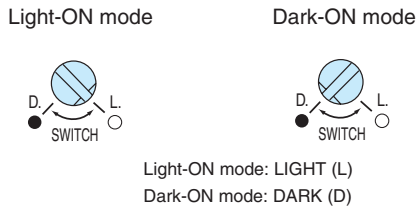

## Indicators

- The operation indicator (red LED) and stability indicator (green LED) show the levels of light intensity as described in the figure below.
- After aligning the optical axis and adjusting the sensitivity, use a detection object to block and unblock the light beam several times to make sure that the sensitivity level is in a range that allows stable activation and deactivation.
- Setting the sensitivity in a range allowing stable operation achieves higher reliability against changes in the operating environment generated after the sensitivity is set.

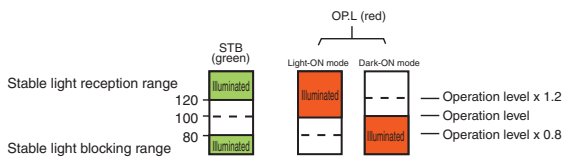

The red LED (OPL) is the operation indicator.  
In the L.ON (Light-ON) mode, the indicator is illuminated when a certain amount of light is detected.  
In the D.ON (Dark-ON) mode, the indicator is illuminated when a certain amount of light is not detected.

## Stability output

The stability output can be used to check for reduction of the light intensity level along with any change in the operating environment or operation over time or to perform initial check of the operation. When two consecutive detections have occurred with the intensity of light detected exceeding the operation level but not reaching 120 % of the level (range allowing stable operation), the stability signal is output when the control output is deactivated.

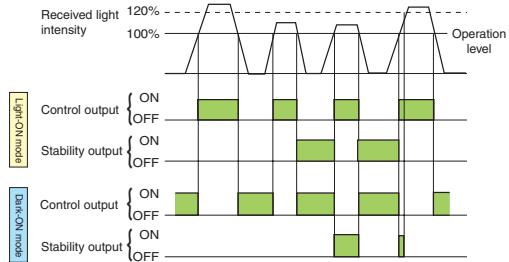

## Sensitivity adjustment (for diffuse-reflective type)

(Adjustment for Light-ON mode)

- When any light-reflecting object is in the background
  - Place the object to be detected in a given position, turn up the sensitivity adjustment volume (SENS.) gradually and find the point at which the operation indicator (red LED) is illuminated (Point A).
  - Remove the object, turn down the sensitivity adjustment volume gradually from MAX. and find the point at which the operation indicator (red LED) goes out (Point B). (If the operation indicator is not illuminated even at Max., MAX. is regarded as Point B.)
  - Set the volume at midway between Points A and B.

