



- **Self-diagnosis feature**

- Sensor signaling an error due to degradation of receiver light intensity level
- Feature applicable to countering soiling of lens or light axis misalignment over time, allowing easy maintenance

- **IP 67 water resistance allows washing**

Sensor when line is washed

- **Visible beam spot for ease of checking (red LED type)**

■ Type

Type	Detecting distance	Model	Light source	Operation mode	Output mode
Short-range	10~30mm	DL-S3R	Red	Light-ON/ Dark-ON selectable (with switch)	NPN open collector
		DL-S3	Infrared		
	10~40mm	DL-S4R	Red		
		DL-S4	Infrared		
	10~50mm	DL-S5R	Red		
		DL-S5	Infrared		
Medium-range	10~100mm	DL-S10R	Red		
		DL-S10	Infrared		
	10~150mm	DL-S15			
	10~200mm	DL-S20			

- **Red LED medium-range type**

Model DL-S20R

Red LED employed as light emitting element for clear identification of detecting position

Detecting distance: 200 mm

Rating/Performance/Specification

Type	Short-range						Medium-range			
	Red LED			Infrared LED			Red LED	Infrared LED		
Model	DL-S3R	DL-S4R	DL-S5R	DL-S3	DL-S4	DL-S5	DL-S10R	DL-S10	DL-S15	DL-S20
Detection method	Distance limited reflection									
Detecting range *1	10-30mm	10-40mm	10-50mm	10-30mm	10-40mm	10-50mm	10-100mm	10-100mm	10-150mm	10-200mm
Range of distance adjustment with volume	10% less than maximum detecting distance			20% less than maximum detecting distance			10% less than maximum detecting distance			
Power supply	12-24V DC \pm 10% / Ripple 10% max.									
Current consumption	27mA max.						30mA max.			
Output mode	Control output			NPN open collector *2 Rating: sink current 100 mA (30 VDC) max.						
	Stability output			NPN open collector *2 Rating: sink current 50 mA (30 VDC) max.						
Operation mode	Light-ON/Dark-ON selectable (with switch)									
Response time	0.35ms max.									
Hysteresis	5% max.									
Light source (light wavelength)	Red LED (700 nm)			Infrared LED (880 nm)			Red LED (700 nm)	Infrared LED (880 nm)		
Light-sensitive element	2-division photodiode									
Indicator	Operation indicator: red LED/Stability indicator: green LED									
Volume (VR)	Distance adjustment volume									
Switch (SW)	Light-ON/Dark-ON selector switch						L.ON: Light-ON D.ON: Dark-ON			
Short circuit protection	Provided (for control output only)									
Material	Case and lens: polyarylate						Case: heat-resistant ABS / Lens: polyethersulfone			
Connection	Permanently attached cord (Outer dimension: dia.3) 0.15sq. 4 core, 2 m length, black						Permanently attached cord (Outer dimension: dia.4) 0.15sq. 4 core, 2 m, black			
Mass	50g max.						80g max.			
Notes	*1 With volume at MAX: white drawing paper of 50×50mm for short-range type, 100×100mm for medium-range type *2 PNP output types available for all models ("PN" added at the end of model No.: Ex. DL-S3RPN) / No stability output provided for PNP output type									

Background suppression photo sensors

Environmental Specification

Ambient light	5,000lx max.
Ambient temperature	-25 - +55°C (non-freezing)
Ambient humidity	35-85%RH (non-condensing)
Protective structure	IP67
Vibration	10-55 Hz / 1.5 mm amplitude / 2 hours each in 3 directions
Shock	500 m/s ² / 10 times each in 3 directions

- Applicable power supply unit

PS Series
High capacity of 200 mA at
12 VDC

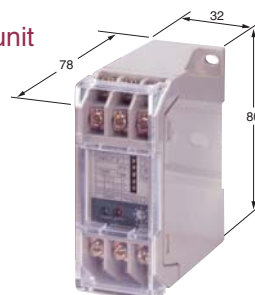

(General-purpose type)
PS3N
PS3N-SR
(Multifunctional type)
PS3F
PS3F-SR

DL-S

Input/Output Circuit and Connection

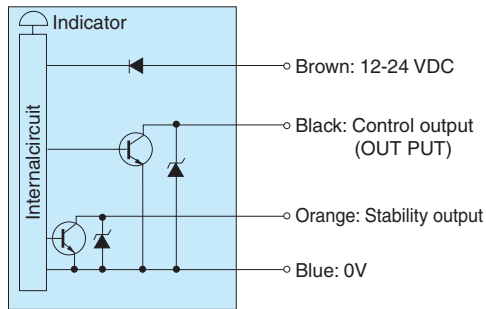

- The output transistor turns off when load short circuit or overload occurs. Check the load and turn the power back on.
- Note that the stability output is not provided with the short circuit protection circuit.

Activation area characteristics (Typical example)

DL-S3R

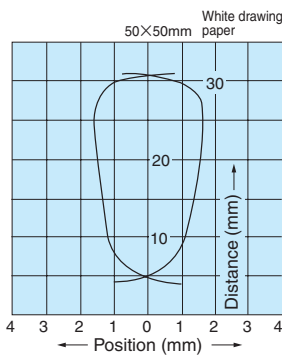

DL-S4R

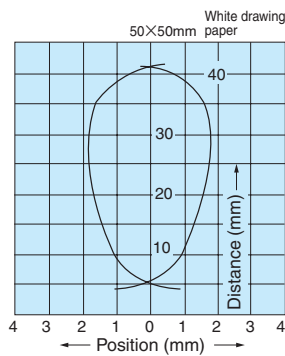

DL-S5R

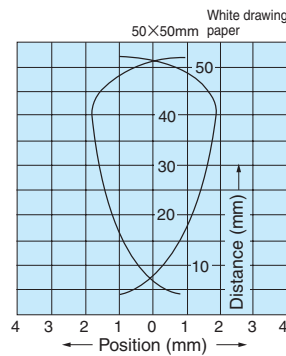

DL-S3

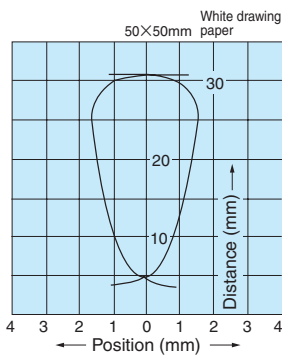

DL-S4

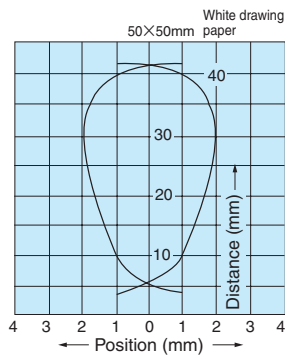

DL-S5

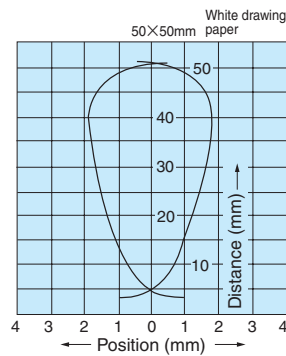

DL-S10R • S10

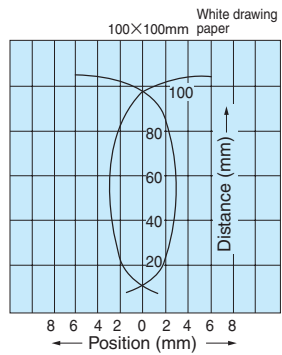

DL-S15

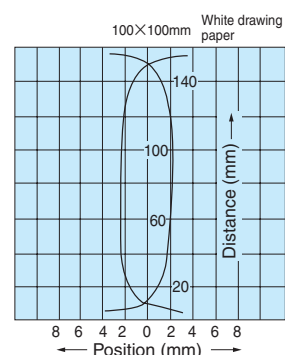

DL-S20

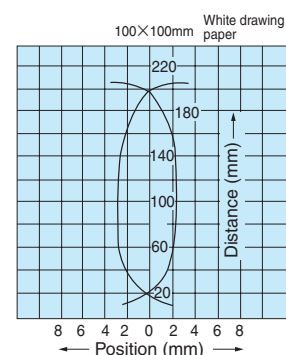

Color Paper Detection Characteristics (Typical Example)

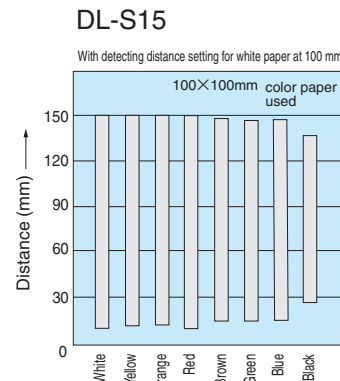
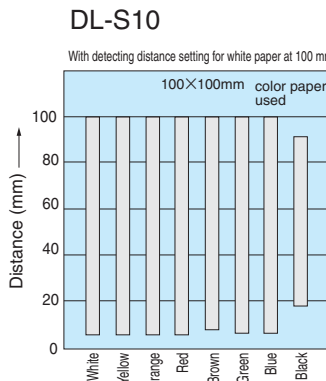
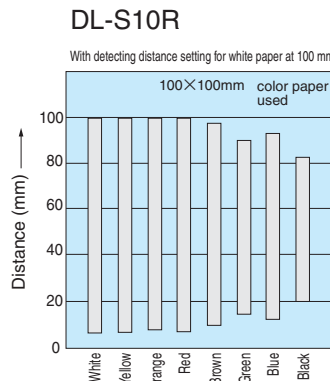
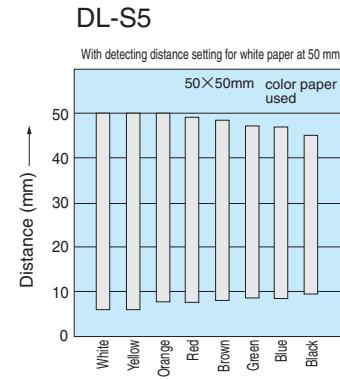
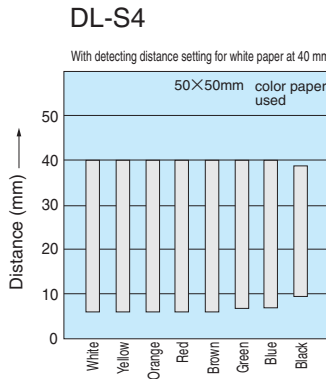
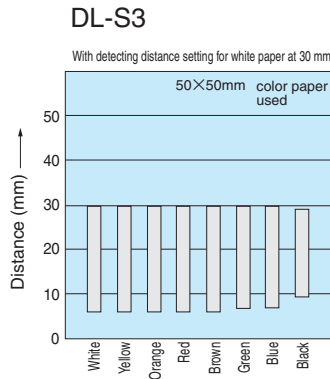
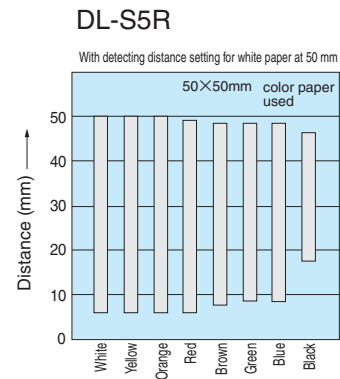
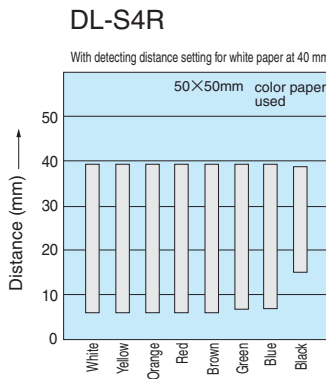
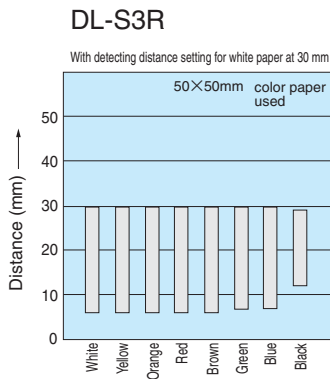

Temperature Characteristics (Typical Example)

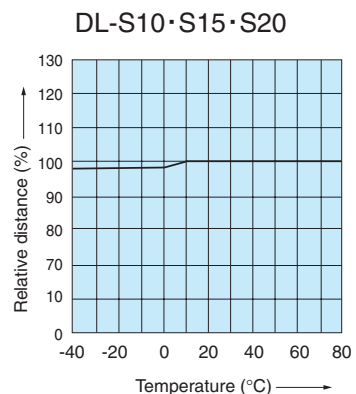
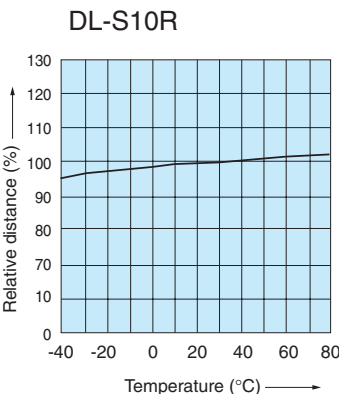
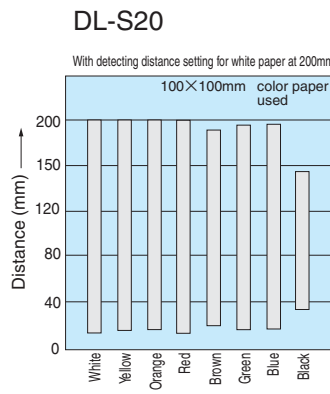

DL-S

Dimensions (in mm)

Short-range

CAD

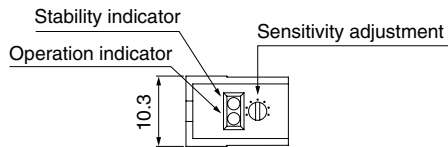

With mounting bracket (accessory) attached

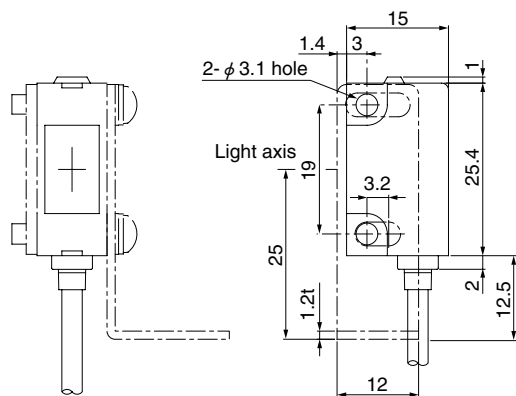
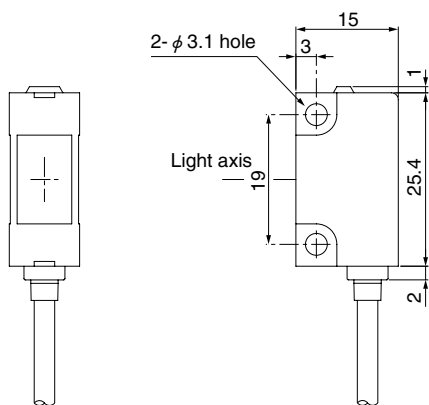
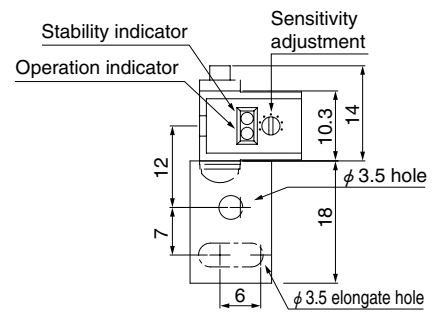

Medium-range

CAD

With mounting bracket (accessory) attached

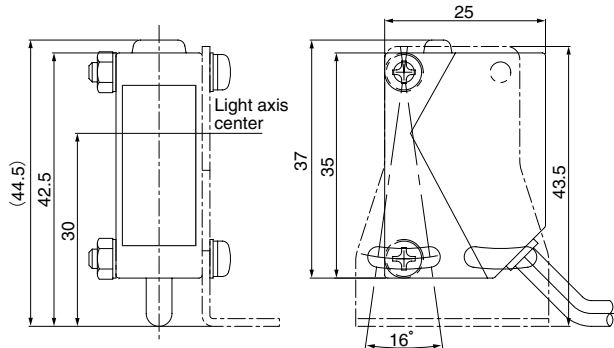
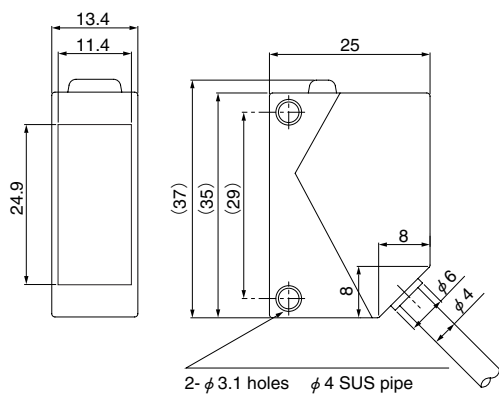
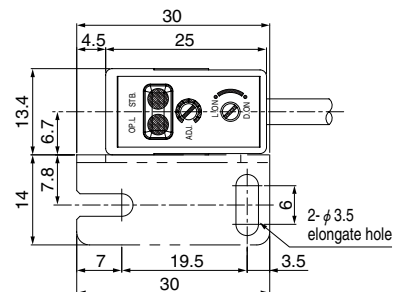
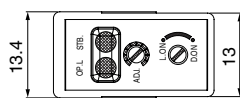

For Correct Use

Be sure to follow the instructions in the operation manual provided for correct use of the product.

Stability output

The stability output can be used to check for reduction of the light intensity level along with any change in the operating environment or operation over time or to perform initial check of the operation.

When detection has occurred with the level of received light exceeding the operation level but not reaching 120% of the level (range allowing stable operation), the stability signal is output when the control output is deactivated.

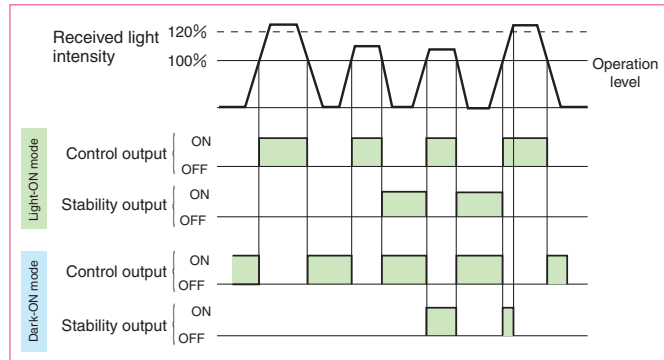

Indicators

- The operation indicator (red LED) and stability indicator (green LED) show the levels of light intensity as described in the figure on the right.
- After aligning the optical axis, use a detection object to block and unblock the light beam several times to make sure that the sensitivity level is in a range that allows stable activation and deactivation.
- Setting the sensitivity in a range allowing stable operation achieves higher reliability against changes in the operating environment generated after the sensitivity is set.

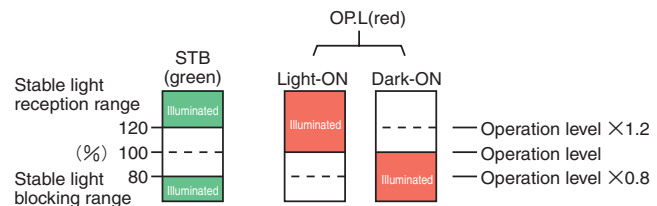

- The red LED (O.P.L) is the operation indicator. In the L.ON (Light-ON) mode, the indicator is illuminated when a certain amount of light is detected. In the D.ON (Dark-ON) mode, the indicator is illuminated when a certain amount of light is not detected.

Light-ON/Dark-ON switching



For Light-ON mode: Set the switch to L (Light).
For Dark-ON mode: Set the switch to D (Dark).

Detecting direction

The 2-division photodiode has directionality and the sensor may not be used in a certain direction. The direction of movement of the object must be as shown in the figure.

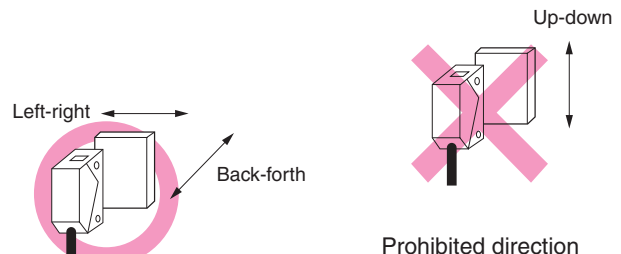

Prohibited direction
*Up-down movement shown in the figure may be allowed within the detecting distance set with the distance adjustment.

Background

Any glossy or mirror-like object present in the background of the detection object may cause faulty operation depending on the angle of the background. In such cases, mount the sensor at an angle.



- High-intensity red LED for ease of light axis adjustment <DL-S100R (-J)>
- Light intensity for long distance offering adverse environment
- Compact size and enhanced functions
- IP 66 protective structure

Type

Type	Detecting distance	Model	Operation mode	Output mode	Power supply
Long-range	0.2~1m	DL-S100R	Light-ON/ Dark-ON selectable (with switch)	NPN/PNP open collector 2 outputs	12-24VDC
		DL-S100R-J			
	0.2~2m	DL-S202(R)			
		DL-S202-J			

Optional parts

Type	Model	Shape
Special mounting bracket	AC-BDL1	Vertical mounting
	AC-BDL2	Back mounting
Cord with M8 connector	FBC-4R2S	Straight
	FBC-4R2L	Angled

Panel display and functions

Operation indicator (red)

Illuminated when output is activated. High-intensity red LED for excellent visibility.

Stability indicator (green)

Illuminated when received light intensity is about 120% of operation level or higher. Use of the sensor at an operation level allowing illumination of the stability indicator ensures stable detection.

Light-ON/Dark-ON selector switch

Turn the switch to L.ON or D.ON for Light-ON or Dark-ON mode respectively.
Be sure to turn all the way to the end.

Distance setting indicator

The position on the distance setting scale is shown in accordance with the 5-turn sensitivity adjustment, allowing easy reading of setting during fine-tuning.

Distance adjustment

5-turn adjustment is employed for easy fine-tuning of detecting position. Turn to FAR or NEAR for longer or shorter detecting distance respectively.



Rating/Performance/Specification

Model	DL-S100R	DL-S100R-J	DL-S202(R)	DL-S202-J
Detection method	Distance limited reflection			
Range	0.2 – 1m (with 200×200mm white drawing paper)		0.2 – 2m (with 200×200mm white drawing paper)	
Detecting distance	0.1 – 1m (with adjustment at MAX.)		0.1 – 2m (with adjustment at MAX.)	
Power supply	12-24V DC ±0% / Ripple 10% or less			
Current consumption	30mA max.			
Output mode	NPN/PNP open collector 2 outputs Rating: 100 mA (30 VDC) max. NPN: sink current / PNP: source current			
Operation mode	Light-ON/Dark-ON selectable (with switch)			
Response time	2 ms max.			
Hysteresis	10% max of detecting distance			
Light source	Red LED (650 nm)		Infrared LED (880 nm)*	
Light-sensitive element	2-division photodiode			
Indicator	Red LED: operation indicator / Green LED: stability indicator			
Volume (VR)	NEAR/FAR: 5-turn optical distance adjustment			
Switch (SW)	Light-ON/Dark-ON selector switch			
Short circuit protection	Provided			
Material	Case and lens: polyarylate			
Connection	Permanently attached cord (Outer dimension: dia.4) 0.2sq. 4 core 2m length	Cord with M8 connector (cord: Outer dimension: dia.4 0.2sq. 4 core 3m length End: M8 4-pin connector)	Permanently attached cord (Outer dimension: dia.4) 0.2sq. 4 core 2m length	Cord with M8 connector (cord: Outer dimension: dia.4 0.2sq. 4 core 3m length End: M8 4-pin connector)
Mass	100g max.	60g max.	100g max.	60g max.

*Red LED type (R added at the end of model No.) separately available

Environmental Specification

Ambient light	Sunlight: illumination on light receiving surface 10,000 lx max. Incandescent lamp: illumination on light receiving surface 3,000 lx max.
Ambient temperature	-25 - +55°C (non-freezing)
Ambient humidity	35-85%RH (non-condensing)
Noise	Power supply line: 250 V / Cycle: 10 ms / Pulse width: 1 μs Radiation: 1 kV / Cycle: 10 ms / Pulse width 1 μs (with noise simulator)
Protective structure	IP66
Vibration	10-55 Hz / 1.5 mm amplitude / 2 hours each in 3 directions
Shock	500 m/s ² / 3 times each in 3 directions
Dielectric withstanding	1,000 VAC for 1 minute
Insulation resistance	500 VDC, 20 MΩ or higher

Input/Output Circuit and Connection

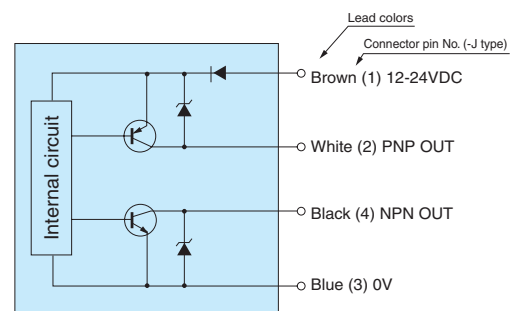

- The output transistor turns off when load short circuit or overload occurs. Check the load and turn the power back on.

Distance detection with 2-division photodiode

While ordinary reflective-type sensors operate based on the received light intensity, sensors with 2-division photodiode judge distances based on the angle of the received light.

This makes sensors with 2-division photodiode to be less susceptible to variation in the received light intensity due to change of the color or material of the detection object, reflection on the background or soiling of the sensors, allowing stable detection.

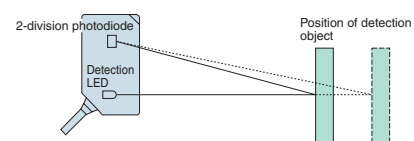

Detection based on change of angle of received light according to change of distance from detection object.

DL-S

Model: DL-S100R Characteristics (Typical Example)

- Activation area characteristics

With 200×200mm white paper at 500 mm

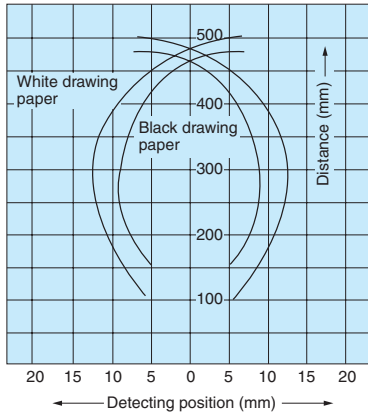

With 200×200mm white paper at 1 m

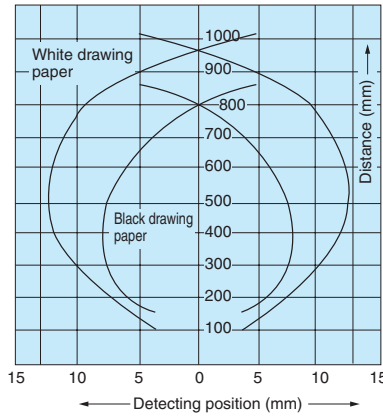

- Emitted light beam diameter

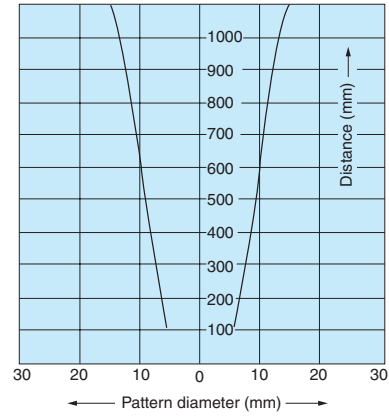

- Color paper detecting distance

150×150mm color paper

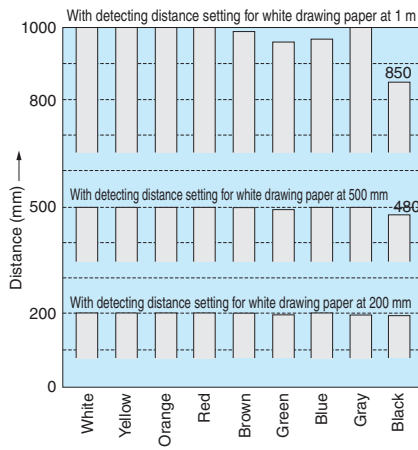

- Detecting distance by material

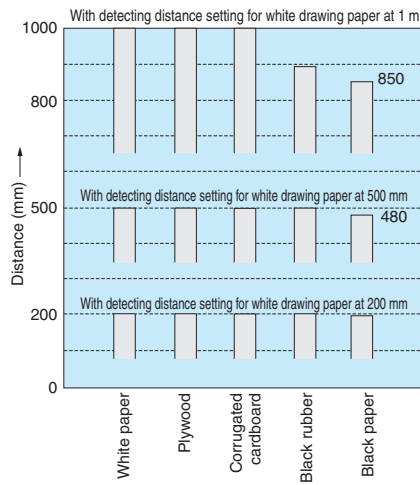

Model: DL-S202R Characteristics (Typical Example)

- Activation area characteristics

With 200×200mm white paper at 1 m

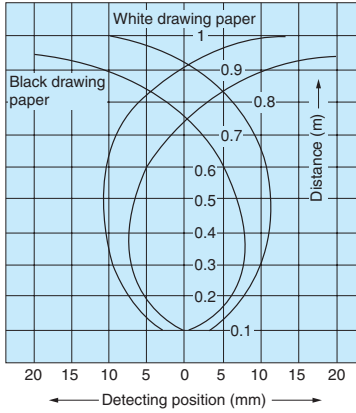

With 200×200mm white paper at 2 m

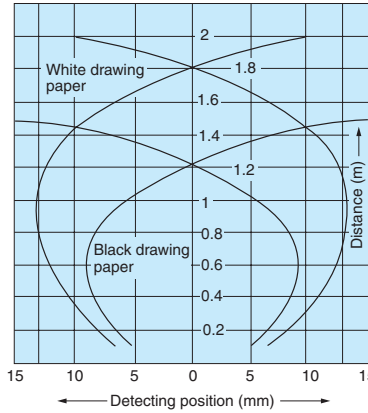

- Emitted light beam diameter

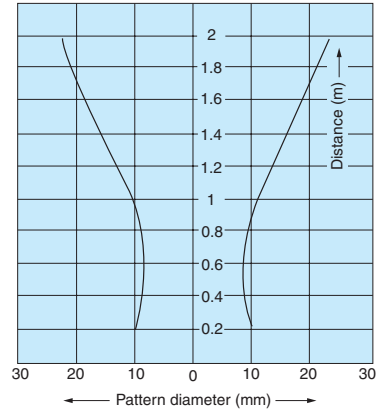

- Color paper detecting distance

150×150mm color paper

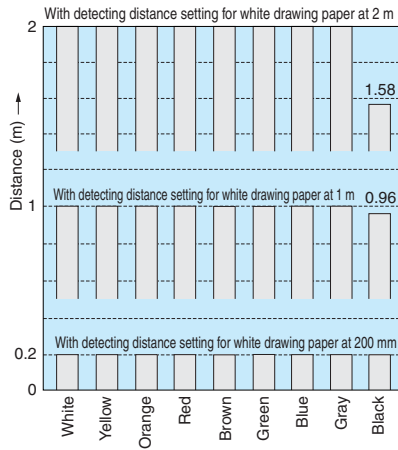

- Detecting distance by material

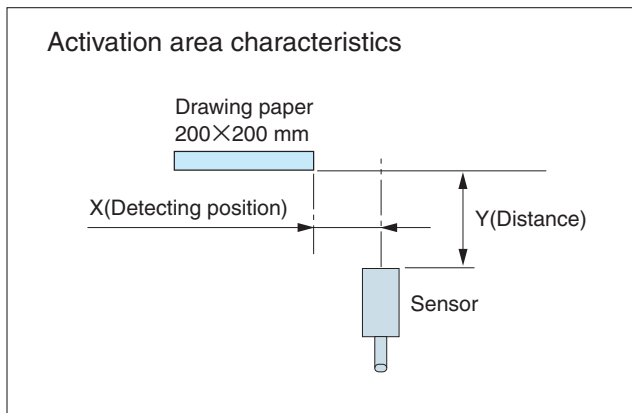
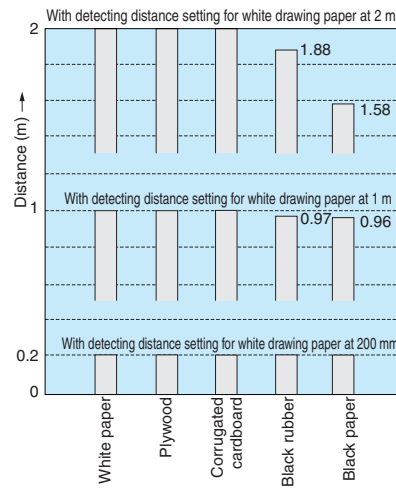

DL-S

Dimensions (in mm)

Body

DL-S100R(-J)
DL-S202(R)(-J)

CAD

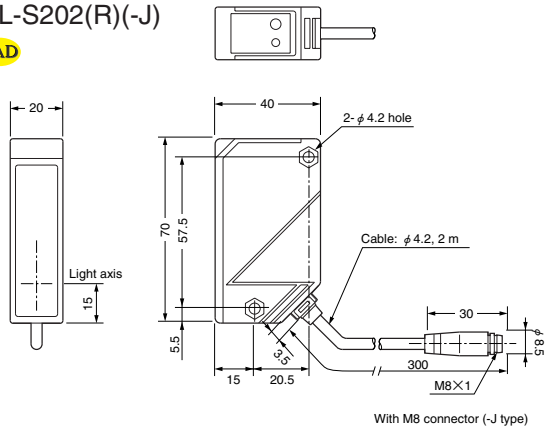

Special mounting bracket (optional)

CAD

With mounting bracket
AC-BDL1 (vertical)
attached

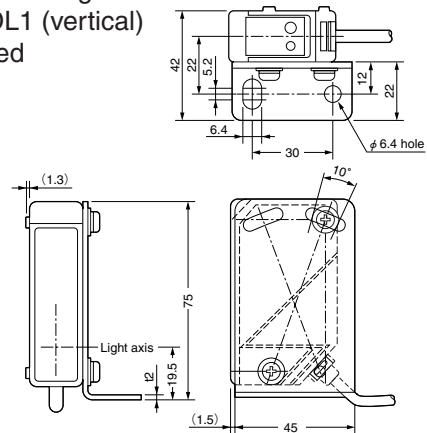

Cord with M8 connector (optional)

FBC-4R2S (straight)

CAD

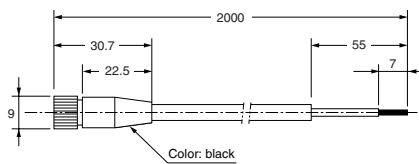

FBC-4R2L (angled)

CAD

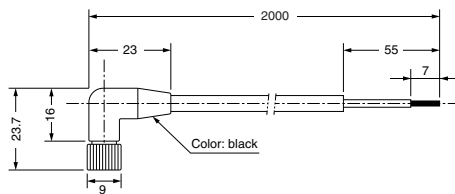

With mounting bracket
AC-BDL2 (back)
attached

CAD

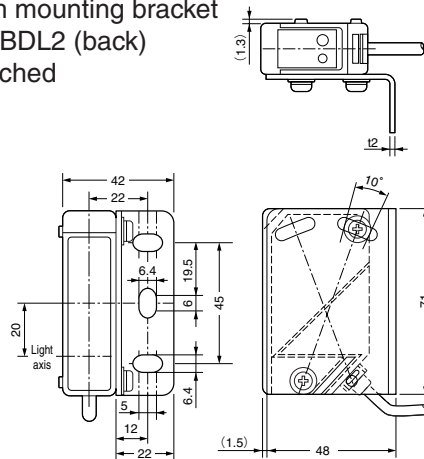

For Correct Use

Be sure to follow the instructions in the operation manual provided for correct use of the product.

• Detecting direction

The 2-division photodiode has directionality and the sensor may not be used in a certain direction. The direction of movement of the object must be as shown in the figure.

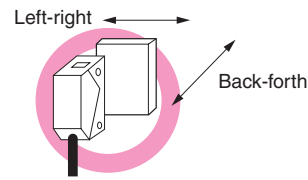

Permitted direction

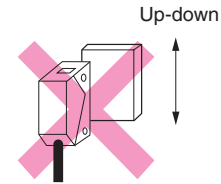

Prohibited direction

Up-down movement shown in the figure may be allowed within the detecting distance set with the distance adjustment.

• Background

Any glossy or mirror-like object present in the background of the detection object may cause faulty operation depending on the angle of the background. In such cases, mount the sensor at an angle.

• Stability indicator

The stability indicator does not show the margin of distance but intensity of light with reference to the operation level. The distance at which the indicator is illuminated/not illuminated may vary depending on the reflectance of the detection object. Situations in which the stability indicator is not illuminated may cause unstable detection.



- Do not use the sensor for protection of human body.
- For safety applications, ensure safe operation of the detection and control system as a whole.