



A08610

Ringlight Holder, A08610, attached to A08600 ringlight. Ringlight Holder, A08610, shown alone with hex key and screws that are included with the product for assembly.



A08611

Ringlight clamp ring, A08611

Ringlight Support Apparatus

For accurate positioning when using fiber optic components in industrial and laboratory environments.



A08601

Ringlight Clamps, A08601



A08614

Anti-Slip Ringlight Clamps, A08614

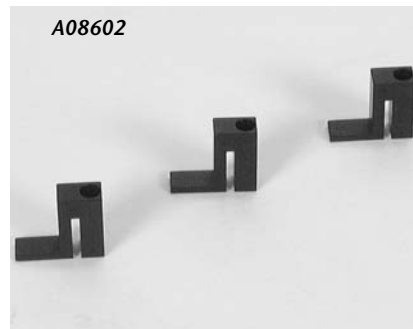

A08602

Ringlight Clamps, A08602



A08702

Ringlight Clamps, A08702

Support Apparatus

Holders, Clamp Rings, and Anti-slip Pads

Part No.	Description
A08601	Ringlight Clamps to fit 33 mm to 46 mm objectives. (3 clamps in package)
A08602	Ringlight Clamps to fit 62 mm to 81 mm objectives. (3 clamps in package)
A08605	Ringlight holder with M6 thread.
A08610	Ringlight holder for Universal Series Ringlights. Enables the user to maintain ringlight working distance while adjusting the microscope or camera. See photo above and drawing on back side.
A08611	Ringlight Clamp Ring for Universal Series Ringlights. Adapts ringlights to fit 47 to 62 mm objectives.
A08612	Ringlight Clamp Ring for Universal Series Ringlights. Adapts ringlights to fit 33 to 46 mm objectives.
A08613	Ringlight Clamp Ring for Universal Series Ringlights. Adapts ringlights to fit 64 to 81 mm objectives.
A08614	Anti-slip Ringlight Clamps for ringlight models A08600, A08620 and A08560. (3 clamps in package)
A08702	Ringlight Clamps for A08700 Ringlight. (3 clamps in package)
A29501	Thumbscrews for midi & mini ringlights. (25 thumbscrews per package)

SUPPORT APPARATUS

Ringlight Support Apparatus

Dimensions in () are in mm

A08605
Holder

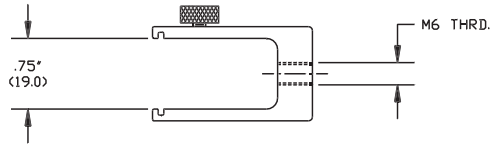

A08610
Holder

(Ringlight & Clamp Ring not included)

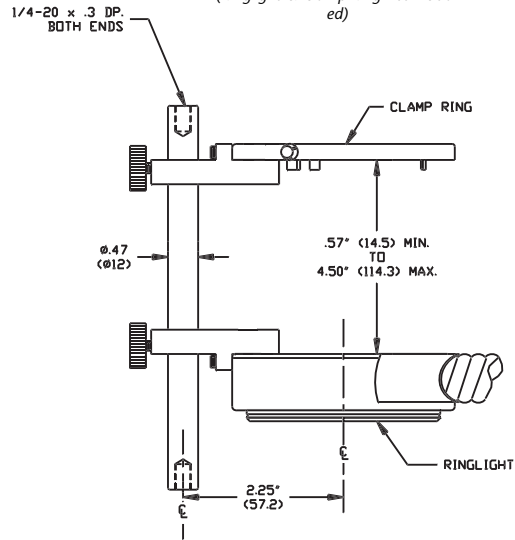

#8-32 MOUNTING HOLES, 2 PLCS.

A08611, A08612 & A08613
Clamp Ring

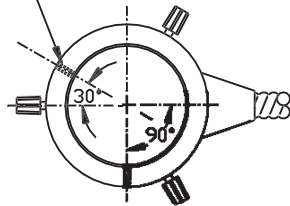

A08702
Ringlight Clamps

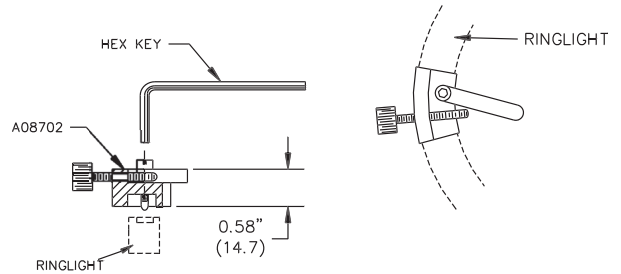

Clamp(s) for
A08611 Clamp Ring,
A08600 and A22000
ringlights and
A08614, Set of 3 Clamps
1.8 / 2.4" (47/62)

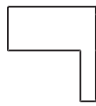

Clamp(s) for
A08612 Clamp Ring,
A08603 ringlight and
A08601, Set of 3 Clamps
1.3 / 1.8" (33/46)

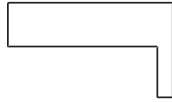

Clamp(s) for
A08613 Clamp Ring,
A08604 ringlight, and
A08602, Set of 3 Clamps
2.4 / 3.2" (62/81)

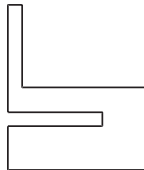

A08614
Clamps with Anti-slip Pads
(Set of 3)

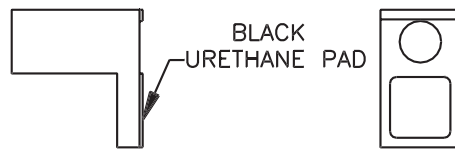

TECHNICAL SPECIFICATIONS