

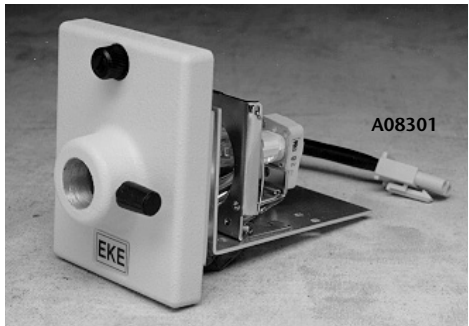

EJA, EKE and DDL Lamps

150 Watt Halogen Lamps		
Part No.	Type	Description
A08110	EJA	3350° K color temperature. 21 Volt. Most intense. Small spot size. Rated 40 hrs., 500 hrs. w/ a dimmer.*
A08120	EKE	3250° K color temperature. 21 Volt. High output for most applications. Rated 200 hrs., 2000 hrs. w/ a dimmer.*
A08130	DDL	3150° K color temperature. 20 Volt. Extremely uniform output. Rated 500 hrs., 5000 hrs. with a dimmer.*

* Voltage reduced to 80% of full intensity.



Modulamp® Assembly, A08301

Modulamp® Assemblies		
Part No.	Type	Description
Standard (without lamp)		
A08301		Lampholder for EKE Lamp
A08301.1		Lampholder for EJA Lamp
A08301.2		Lampholder for DDL Lamp
Iris Diaphragm (without lamp)		
A08321		Lampholder for EKE Lamp
A08321.1		Lampholder for EJA Lamp
A08321.2		Lampholder for DDL Lamp

Lamps & Modulamp® Assemblies

Lamp Features

- 150 watt tungsten halogen bulbs.
- EJA, EKE and DDL types available.
- Use with ACE® series and DCR® series light sources.
- The correct lamp for your light source is specified on the label located on the front of the Modulamp® unit.
- More specifications are in the chart on the left and on the back side of this page.

Modulamp® Assembly Features

- Assures maximum light delivery to fiber optic components.
- Use with all ACE® series and DCR® series light sources.
- Full illumination on .60" (15 mm) active diameter input.
- Interchangeable Modulamp® units offer 2 lamp positions to maximize individual lamp efficiencies.
- Choice of three, 150 watt halogen lamps - EJA, EKE, DDL for intense, uniform illumination.
- IR interference filter for cool illumination.
- Iris version also available. See chart on left.
- 2-year warranty (excludes lamp and socket).
- In stock and ready to ship.
- Manufactured in the USA.

Lamp Socket



Lamp Socket	
Part No.	Description
A29506	Lamp Socket for ACE® series and DCR® series light sources.

Lamps and Modulamp® Assemblies

Dimensions in () are in mm

A08110, A08120 & A08130 - Lamp Beam Patterns

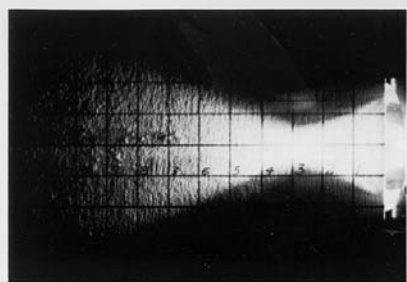

EJA 21V, 150W
FIBER OPTICS PROJECTION

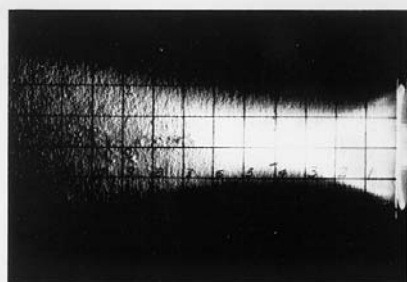

EKE 21V, 150W
8MM PROJECTION

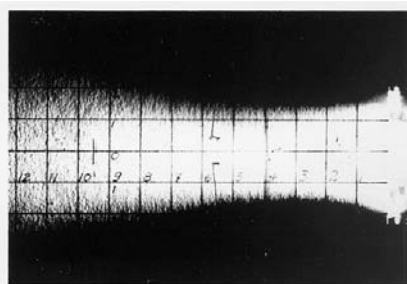

DDL 20V, 150W
MICROFILM PROJECTION

Beam Patterns are Courtesy of GE

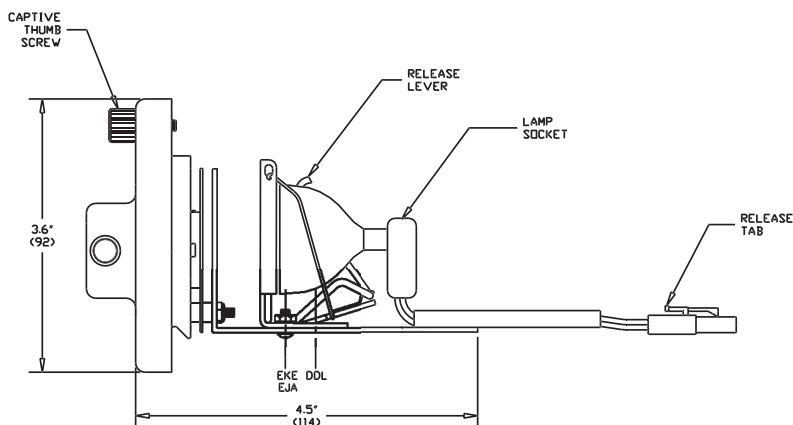

A08301, A08301.1 & A08301.2 - Modulamp® Assemblies

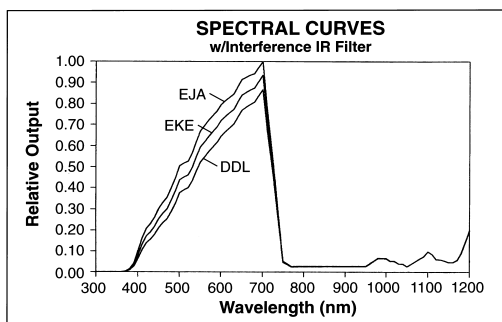

Front View of
Modulamp® Assembly

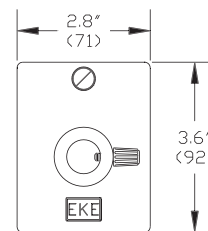

Lamp Specifications

Bulb Type	Voltage	Wattage	Lamp Base	Bulb Finish	Burn Position	Shape	Color Temp.	Filament	Lamp Fill	Lamp Life	Over All Length (mm)	Reflector Design	Reflector Size (mm)	Working Distance (mm)
EJA	21	150	GX5.3	Clear Horiz.	Base/Down	MR-16	3350	CC-6	Halogen	40 Hrs.	44.5	Dichroic	50.7	28.0
EKE	21	150	GX5.3	Clear	Base/Down Horiz.	MR-16	3250	CC-6	Halogen	200 Hrs.	44.5	Dichroic	50.7	44.5
DDL	20	150	GX5.3	Clear	Base/Down Horiz.	MR-16	3150	CC-6	Halogen	500 Hrs.	44.5	Dichroic	50.7	194.5