

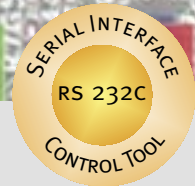

CV-M7⁺/M7⁺CL

Digital Double Speed Color Megapixel Progressive Scan Camera



- **Digital 2/3" color progressive scan CCD camera**
- **RGB primary color mosaic filter (Bayer) for host based RGB decoding**
- **1392 (h) x 1040 (v) 6.45 μ m square pixels**
- **Extended sensitivity compared with CV-M7**
- **8 bit video output as LVDS (EIA 644) using 10 bit internal processing**
- **Camera Link version with 10 bit video output**
- **Full 1380 (h) x 1030 (v) frame readout in 1/24 second**
- **Partial scan to 1/2, 1/4 and 1/8 for higher frame rate**
- **Edge pre-select and pulse width external trigger modes**
- **Frame-delay and smearless readout modes**
- **Multiple exposure with up to 6 exposures within a single frame**
- **Shutter speeds from 1/24 to 1/10,000 second in 10 steps**
- **Trigger and timing signals as LVDS or via Camera Link**
- **Setup by switches or serial control (short ASCII commands)**
- **Windows 98/NT/2000 setup software**

The leading manufacturer of high performance camera solutions

Specifications for CV-M7+/CV-M7+CL

Specifications	CV-M7+/CV-M7+CL
Scanning system	Progressive 1060 lines 24 frames/sec.
Pixel clock	40.49 MHz
Line frequency	25.43 kHz (1592 pixel clock/line)
Frame rate for full frame	24 frames/sec. (1060 lines/frame)
CCD sensor	2/3" progressive scan IT CCD with RGB primary color mosaic filter (Bayer)
Sensing area	8.9 (h) x 6.6 (v) mm
Cell size	6.45 (h) x 6.45 (v) (μm)
Effective pixels	1392 (h) x 1040 (v)
Pixels in video output	
Full	1380 (h) x 1030 (v) 24 frames/sec.
1/2 partial	1380 (h) x 512 (v) 44 frames/sec.
1/4 partial	1380 (h) x 256 (v) 70 frames/sec.
1/8 partial	1380 (h) x 128 (v) 102 frames/sec.
Sensitivity on sensor	0.1 Lux (Max. gain, 50% video)
S/N ratio	>57 dB
Video A/D conversion	10 bit
Video output digital (RGB in Bayer mosaic sequence for external RGB decoding)	8 bit LVDS (EIA 644) 10 bit in Camera Link
Video out (analogue for test)	0.7 Vpp, 75 Ω
Gamma	1.0
Gain	Manual - Automatic
Gain range	-3 to +12 dB
Synchronization	Int. X-tal. Ext. random trigger
Sync. output	Composite 4 Vpp from 75 Ω
Trigger input TTL	4 V ± 2 V
EEN output	4 Vpp from 75 Ω
Pixel clock output	LVDS or Camera Link
LEN/FEN output	LVDS or Camera Link
Trigger input LVDS	LVDS or Camera Link
Multiple exposure	LVDS or Camera Link
Trigger modes	Continuous, Edge pre-select, Pulse width control
Trigger in (Edge pre-select)	>2 H
Shutter speed (fixed)	1/24 through 1/10,000 second
Pulse width control	2 H to 3 frames. (80 μsec. to 72 msec.)
Frame-delay readout	Fixed shutter speeds. Delay ≤ 3 frames
Smearless readout	Edge pre-select, PWC and frame-delay
Multiple exposure Interval	≤6 fixed exposures in frame-delay readout. Fixed shutter time + 1H (80 μsec.)
Camera setup by switches on rear	Shutter, Trigger, Scanning, Smearless, RS 232C control
Functions controlled by RS 232C	Shutter, Trigger, Scanning, Readout, Trigger input, Select/polarity, LEN/FEN/EEN polarity, Set-up level and Gain
Operating temperature	-5°C to +45°C
Humidity	20 - 80% non-condensing
Storage temp./humidity	-25°C to 60°C/ 20% - 90%
Power	12V DC ± 10%. 3.3 W
Lens mount	C-mount
Dimensions	40 x 50 x 90 mm (HxWxD)
Weight	250g

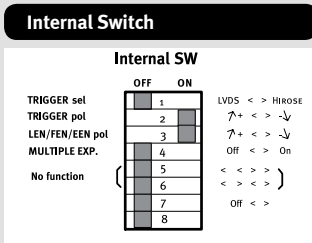
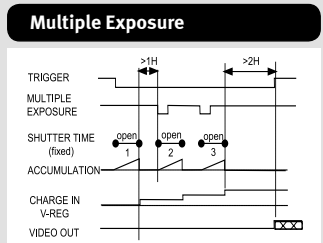

Connection Description

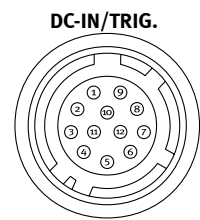

- HIROSE HR10A-10R-12P
- Pin 1 Ground
 2 +12V DC
 3 Ground
 4 Video output (test)
 5 Ground
 6 RXD RS 232C
 7 TXD RS 232C
 8 Ground
 9 Sync. output/EEN output*
 10 Trigger input (TTL)*
 11 +12V DC/Multiple exposure*
 12 Ground

* Signals can be changed by internal switches and jumpers or via RS 232C.

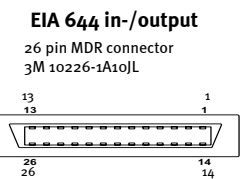

- ### Digital I/O
- | Pin | Signal |
|-----|-------------------------------|
| 1 | 14 +/- D0 Video output (LSB) |
| 2 | 15 +/- D1 Video output |
| 3 | 16 +/- D2 Video output |
| 4 | 17 +/- D3 Video output |
| 5 | 18 +/- D4 Video output |
| 6 | 19 +/- D5 Video output |
| 7 | 20 +/- D6 Video output |
| 8 | 21 +/- D7 Video output (MSB) |
| 9 | 22 +/- TRIG Trigger input |
| 10 | 23 +/- Mult Multiple exposure |
| 11 | 24 +/- LEN Line enable |
| 12 | 25 +/- FEN Frame enable |
| 13 | 26 +/- PCLK Pixel clock |

EIA 644 in and output circuits
 NS. D590C031/D590C032

For Camera Link pin configuration, see user manual.

Spectral Sensitivity

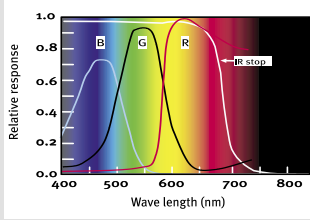

Dimensions

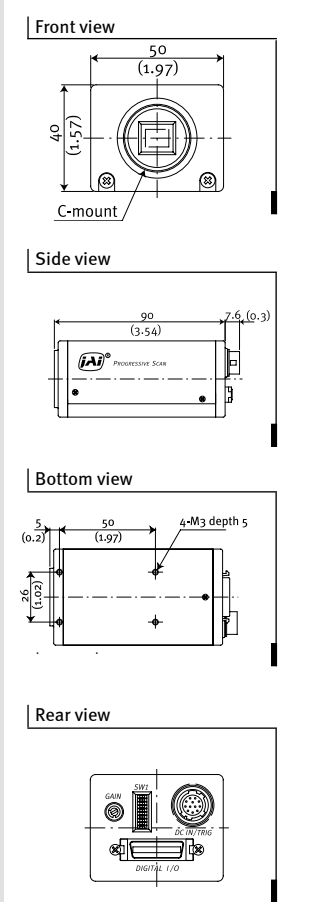

Switch Setting

	OFF	ON	
SHUTTER	1	1/24	seconds
	2	1/50	
	3	1/100	
	4	1/200	
EXT. TRIGGER	5	Off	Frame delay
	6	Edge pre sel.	
	7	Pulse width	
	8	Frame delay	
SCANNING	9	Full	Smear-less
	10	1/2 part.	
SMEAR-LESS	11	1/4 part.	1/8 part.
	12	1/8 part.	
CONTROL	13	Local	RS232C

Ordering Information

CV-M7 2/3" Digital Double Speed Color Megapixel Progressive Scan Camera. LVDS
 CV-M7+CL 2/3" Digital Double Speed Color Megapixel Progressive Scan Camera. Camera Link



THE MECHADEMIC COMPANY

Company and product names mentioned in this datasheet are trademarks or registered trademarks of their respective owners. IAI/AS cannot be held responsible for any technical or typographical errors and reserves the right to make changes to products and documentation without prior notification.